

<b>TEST REPORT</b> <b>J62133-2(2021)( JIS C 62133-2:2020)</b> <b>Secondary cells and batteries containing alkaline or other non-acid electrolytes – Safety requirements for portable sealed secondary cells, and for batteries made from them, for use in portable applications –</b> <b>Part 2: Lithium systems</b>	
<b>Report Number.....</b>	RHDTL260316073
<b>Date of issue.....</b>	2026.04.17
<b>Total number of pages.....</b>	39 pages
<b>Tested by (name + signature).....</b>	QiaoLi Chen <i>Qiaoli Chen</i>
<b>Reviewed by (name + signature).....</b>	Brian Liu <i>Brian Liu</i>
<b>Approved by (name + signature).....</b>	Chris Zhao <i>Chris Zhao</i>
<b>Testing Laboratory Name .....</b>	Dongguan HDTL Technology Co., Ltd.
<b>Address .....</b>	Room 101, Building 1, No. 5 of Jinzhong Road, Dongcheng Street, Dongguan City, Guangdong Province, China.
<b>Applicant's name.....</b>	Shenzhen Liangtou Technology Co., Ltd
<b>Address.....</b>	2nd Floor, Building A, No. 3 East Zone, Shangxue Technology Park, Bantian Street, Longgang District, Shenzhen, Guangdong Province,China
<b>Test specification:</b>	
<b>Standard.....</b>	<input checked="" type="checkbox"/> J62133-2(2021)( JIS C 62133-2:2020) <input type="checkbox"/> IEC 62133-2:2017+AMD1:2021 <input type="checkbox"/> EN 62133-2:2017+AMD1:2021
<b>Test item description.....</b>	Power bank
<b>Trade Mark.....</b>	/
<b>Manufacturer.....</b>	Shenzhen Liangtou Technology Co., Ltd
<b>Address.....</b>	2nd Floor, Building A, No. 3 East Zone, Shangxue Technology Park, Bantian Street, Longgang District, Shenzhen, Guangdong Province,China
<b>Model/Type reference.....</b>	K18 CL18 K20 K28 K38 K08 G18
<b>Ratings.....</b>	DC5V 27230mAh,9V 15100mAh,12V 11300mAh ,14V 9720mAh (@C5) Integrated battery:3.7V 46000mAh 170.2Wh

**List of Attachments (including a total number of pages in each attachment):**

--

**Summary of testing:**

The unit is charging the empty cell and discharging the full charged cell according to the rating.

Note:

Charging procedures for test purposes:

- (1) Unless otherwise stated, the charging procedure for test purposes is carried out in an ambient temperature of  $20\pm 5^{\circ}\text{C}$ , using the method declared by the manufacturer. Prior to charging, the battery/cell shall have been discharged at  $20\pm 5^{\circ}\text{C}$  at a constant current of 0.2 It A down to a specified final voltage.
- (2) After stabilization for 1 to 4 hours respectively at ambient temperature of highest test temperature  $45^{\circ}\text{C}$  and lowest test temperature  $0^{\circ}\text{C}$ .

**Tests performed (name of test and test clause):**

clause 7.2.1 Continuous charging at constant voltage (cells)  
 clause 7.2.2 Case stress at high ambient temperature (battery)  
 clause 7.3.1 External short-circuit (cell)  
 clause 7.3.2 External short circuit (battery)  
 clause 7.3.3 Free fall  
 clause 7.3.5 Crush (cells)  
 clause 7.3.6 Over-charging of battery  
 clause 7.3.7 Forced discharge (cells)  
 clause 7.3.8.1 Vibration  
 clause 7.3.8.2 Mechanical shock  
 clause 7.3.9 Forced internal short circuit (cells)  
 clause 7.2.2A Temperature cycle (cells)  
 clause 7.3.8.A Low pressure (cells)  
 Clause 7.3.8.B High rate charge (cells)  
 The samples comply with the requirements of J62133-2(2021)( JIS C 62133-2:2020 ).

**Testing location:**

Dongguan HDTL Technology Co., Ltd.  
 Room 101, Building 1, No. 5 of Jinzhong Road,  
 Dongcheng Street, Dongguan City, Guangdong  
 Province, China.

**Summary of compliance with National Differences (List of countries addressed):**

Republic of Japan

The product fulfils the requirements of J62133-2(2021)( JIS C 62133-2:2020 ).

**Copy of marking plate:**

The artwork below may be only a draft. The use of certification marks on a product must be authorized by the respective NCBs that own these marks.



<b>Test item particulars.....</b>	: Power bank
<b>Classification of installation and use.....</b>	: To be defined in final product
<b>Supply connection.....</b>	: Lead wire
<b>Recommend charging method declared by the manufacturer.....</b>	: Under ambient temperatures of 20°C ± 5°C, charge with 5V=3A until full charge.
<b>Discharge current (0,2 I<sub>t</sub> A).....</b>	: 3A
<b>Maximum discharging current.....</b>	: 5V=3A
<b>Specified final voltage.....</b>	: --
<b>Recommend of charging limit for lithium system</b>	
<b>Upper limit charging voltage per cell.....</b>	: 4.2V
<b>Maximum charging current.....</b>	: 3A
<b>Charging temperature upper limit.....</b>	: 45°C
<b>Charging temperature lower limit.....</b>	: 10°C
<b>Polymer cell electrolyte type.....</b>	: <input type="checkbox"/> gel polymer..... <input type="checkbox"/> solid polymer <input checked="" type="checkbox"/> N/A
<b>Possible test case verdicts:</b>	
- test case does not apply to the test object.....	: N/A
- test object does meet the requirement.....	: P (Pass)
- test object does not meet the requirement.....	: F (Fail)
<b>Testing.....</b>	
<b>Date of receipt of test item.....</b>	: 2026.03.16
<b>Date (s) of performance of tests.....</b>	: 2026.03.16 ~ 2026.04.17
<b>General remarks:</b>	
The test results presented in this report relate only to the object tested.	
This report shall not be reproduced, except in full, without the written approval of the Issuing testing laboratory.	
"(See Enclosure #)" refers to additional information appended to the report.	
"(See appended table)" refers to a table appended to the report.	
<b>Throughout this report a <input type="checkbox"/> comma / <input checked="" type="checkbox"/> point is used as the decimal separator.</b>	
<b>General product information:</b>	
1. The maximum ambient temperature is specified as 45°C.	

**General product information:**

This battery is constructed with 2 Li-ion Cell(1S2P), and the cells were passed the standard J62133-2(2021)( JIS C 62133-2:2020).

The main features of the battery are shown as below (clause 8.1.1):

Model	Nominal capacity	Nominal voltage	Nominal Charge Current	Nominal Discharge Current	Maximum Charge Current	Maximum Discharge Current	Maximum Charge Voltage	Cut-off Voltage
K18	27230mAh (@DCV) , 15100mAh (@DC9V) , 11300mAh (@DC12V) , 9720mAh (@DC14V)	DC5V,9 V, 12V,14 V	5V---3A 9V---2A 12V---1A 14V---1A	5V---3A 9V---2A 12V---1A 14V---2A	5V---3A 9V---2A 12V---1A 14V---3A	5V---3A 9V---2A 12V---1A 14V---4A	--	--

The main characteristics of the battery pack are shown as follows (Clause 8.1.2):

Model	Nominal capacity	Nominal voltage	Nominal Charge Current	Nominal Discharge Current	Maximum Charge Current	Maximum Discharge Current	Maximum Charge Voltage	Cut-off Voltage
1260110-2P	46000mAh	3.7V	4600mA	4600mA	11500mA	11500mA	4.20V	3.0V

The main features of the cell in the battery are shown as below (clause 8.1.1):

Model	Nominal capacity	Nominal voltage	Nominal Charge Current	Nominal Discharge Current	Maximum Charge Current	Maximum Discharge Current	Maximum Charge Voltage	Cut-off Voltage
1260110	23000mAh	3.7V	4600mA	4600mA	11500mA	11500mA	4.2V	3V

The main features of the cell in the battery are shown as below (clause 8.1.2):

Model	Upper limit charge voltage	Taper-off current	Lower charge temperature	Upper charge temperature
1260110	4.2V	50mA	10℃	45℃

Construction:



Circuit diagram:

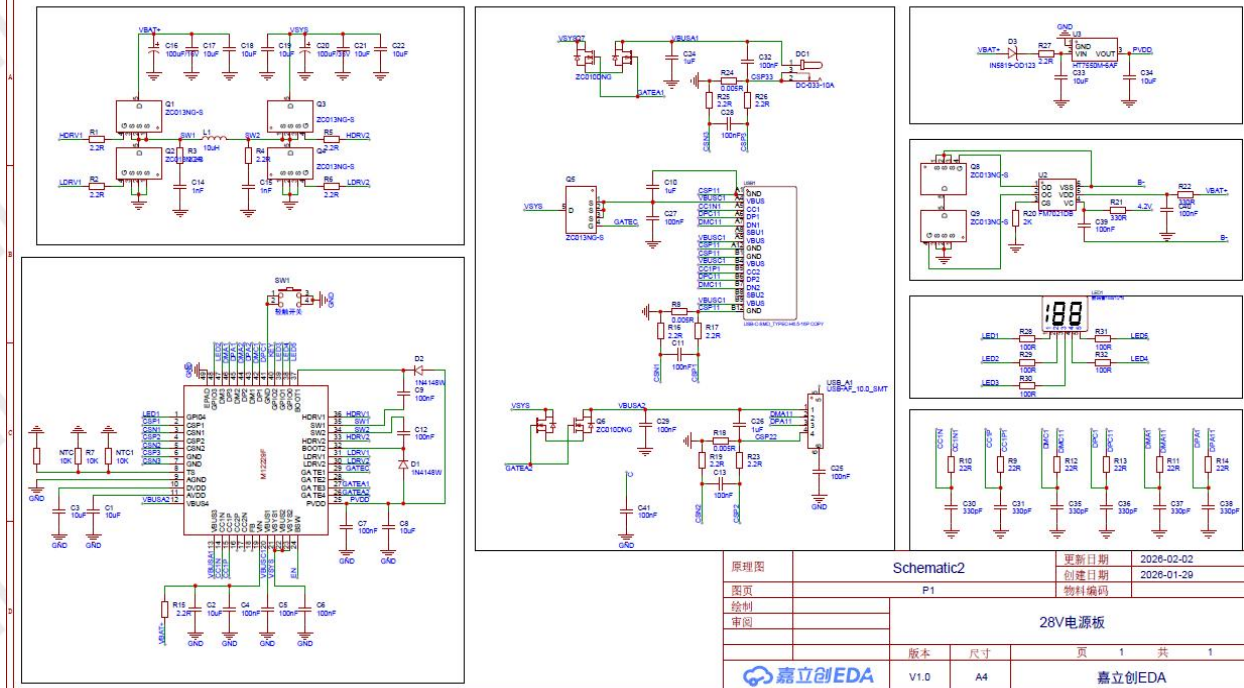

原理图	Schematic2	更新日期	2026-02-02
图页	P1	创建日期	2026-01-29
除制		物料编码	
审阅			
28V电源板			
版本	尺寸	页	共
V1.0	A4	1	1
嘉立创EDA			

<b>JIS C 62133-2:2020</b>			
Clause	Requirement + Test	Result - Remark	Verdict
<b>4</b>	<b>PARAMETER MEASUREMENT TOLERANCES</b>		P
	Parameter measurement tolerances		P
<b>5</b>	<b>GENERAL SAFETY CONSIDERATIONS</b>		P
<b>5.1</b>	<b>General</b>		P
	Cells and batteries so designed and constructed that they are safe under conditions of both intended use and reasonably foreseeable misuse		P
<b>5.2</b>	<b>Insulation and wiring</b>		P
	The insulation resistance between the positive terminal and externally exposed metal surfaces of the battery (excluding electrical contact surfaces) is not less than 5 MΩ	No metal surface exists.	P
	Insulation resistance (MΩ)..... :		—
	Internal wiring and insulation are sufficient to withstand maximum anticipated current, voltage and temperature requirements	Complied.	P
	Orientation of wiring maintains adequate clearance and creepage distances between conductors	Complied.	P
	Mechanical integrity of internal connections accommodates reasonably foreseeable misuse		N/A
<b>5.3</b>	<b>Venting</b>		P
	Battery cases and cells incorporate a pressure relief mechanism or are constructed so that they relieve excessive internal pressure at a value and rate that will preclude rupture, explosion and self-ignition		P
	Encapsulation used to support cells within an outer casing does not cause the battery to overheat during normal operation nor inhibit pressure relief		P
<b>5.4</b>	<b>Temperature, voltage and current management</b>		P
	Batteries are designed such that abnormal temperature rise conditions are prevented		P
	Batteries are designed to be within temperature, voltage and current limits specified by the cell manufacturer		P
	Batteries are provided with specifications and charging instructions for equipment manufacturers so that specified chargers are designed to maintain charging within the temperature, voltage and current limits specified		P
<b>5.5</b>	<b>Terminal contacts</b>		P

<b>JIS C 62133-2:2020</b>			
Clause	Requirement + Test	Result - Remark	Verdict
	The size and shape of the terminal contacts ensure that they can carry the maximum anticipated current		P
	External terminal contact surfaces are formed from conductive materials with good mechanical strength and corrosion resistance	Complied.	P
	Terminal contacts are arranged to minimize the risk of short-circuit	Complied.	P
<b>5.6</b>	<b>Assembly of cells into batteries</b>		P
5.6.1	General		P
	Each battery have an independent control and protection for current, voltage, temperature and any other parameter required for safety and to maintain the cells within their operating region	1S2P	P
	This protection may be provided external to the battery such as within the charger or the end devices		P
	If protection is external to the battery, the manufacturer of the battery provide this safety relevant information to the external device manufacturer for implementation		P
	If there is more than one battery housed in a single battery case, each battery have protective circuitry that can maintain the cells within their operating regions		N/A
	Manufacturers of cells specify current, voltage and temperature limits so that the battery manufacturer/designer may ensure proper design and assembly	Current, voltage and temperature limits specified by cell manufacturer.	P
	Batteries that are designed for the selective discharge of a portion of their series connected cells incorporate circuitry to prevent operation of cells outside the limits specified by the cell manufacturer		P
	Protective circuit components added as appropriate and consideration given to the end-device application		P
	The manufacturer of the battery provide a safety analysis of the battery safety circuitry with a test report including a fault analysis of the protection circuit under both charging and discharging conditions confirming the compliance		N/A
5.6.2	Design recommendation		P
	For the battery consisting of a single cell or a single cellblock, it is recommended that the charging voltage of the cell does not exceed the upper limit of the charging voltage specified in Table 2		P

<b>JIS C 62133-2:2020</b>			
Clause	Requirement + Test	Result - Remark	Verdict
	For the battery consisting of series-connected plural single cells or series-connected plural cellblocks, it is recommended that the voltages of any one of the single cells or single cellblocks does not exceed the upper limit of the charging voltage, specified in Table 2, by monitoring the voltage of every single cell or the single cellblocks		N/A
	For the battery consisting of series-connected plural single cells or series-connected plural cellblocks, it is recommended that charging is stopped when the upper limit of the charging voltage is exceeded for any one of the single cells or single cellblocks by measuring the voltage of every single cell or the single cellblocks	Charging voltage: 4.2V	P
	For batteries consisting of series-connected cells or cell blocks, nominal charge voltage not be counted as an overcharge protection		N/A
	For batteries consisting of series-connected cells or cell blocks, cells have closely matched capacities, be of the same design, be of the same chemistry and be from the same manufacturer		N/A
	It is recommended that the cells and cell blocks not discharged beyond the cell manufacturer's specified final voltage	Final voltage of battery: 3.0V, not exceed the final voltage specified by cell manufacturer.	P
	For batteries consisting of series-connected cells or cell blocks, cell balancing circuitry incorporated into the battery management system		P
5.6.3	Mechanical protection for cells and components of batteries		N/A
	Mechanical protection for cells, cell connections and control circuits within the battery provided to prevent damage as a result of intended use and reasonably foreseeable misuse		N/A
	The mechanical protection can be provided by the battery case or it can be provided by the end product enclosure for those batteries intended for building into an end product		N/A
	The battery case and compartments housing cells designed to accommodate cell dimensional tolerances during charging and discharging as recommended by the cell manufacturer		N/A
	For batteries intended for building into a portable end product, testing with the battery installed within the end product considered when conducting mechanical tests		N/A
<b>5.7</b>	<b>Quality plan</b>		P

JIS C 62133-2:2020			
Clause	Requirement + Test	Result - Remark	Verdict
	The manufacturer prepares and implements a quality plan that defines procedures for the inspection of materials, components, cells and batteries and which covers the whole process of producing each type of cell or battery	Complied. ISO 9001: 2008 certificate provided.	P
<b>5.8</b>	<b>Battery safety components</b>		P
	According annex F	See TABLE: Critical components information	P

<b>6</b>	<b>TYPE TEST AND SAMPLE SIZE</b>		P
	Tests are made with the number of cells or batteries specified in Table 1 using cells or batteries that are not more than six months old		P
	Coin cells with resistance $\leq 3 \Omega$ (measured according annex D) are tested according table 1	Not coin cells	N/A
	Unless otherwise specified, tests are carried out in an ambient temperature of $20 \text{ }^\circ\text{C} \pm 5 \text{ }^\circ\text{C}$		P
	The safety analysis of 5.6.1 identify those components of the protection circuit that are critical for short-circuit, overcharge and overdischarge protection		P
	When conducting the short-circuit test, consideration given to the simulation of any single fault condition that is likely to occur in the protecting circuit that would affect the short-circuit test	See clause 7.3.2.	P

<b>7</b>	<b>SPECIFIC REQUIREMENTS AND TESTS</b>		P
<b>7.1</b>	<b>Charging procedure for test purposes</b>	Complied.	P
7.1.1	First procedure		P
	This charging procedure applies to subclauses other than those specified in 7.1.2		P
	Unless otherwise stated in this document, the charging procedure for test purposes is carried out in an ambient temperature of $20 \text{ }^\circ\text{C} \pm 5 \text{ }^\circ\text{C}$ , using the method declared by the manufacturer	See page 2.	P
	Prior to charging, the battery have been discharged at $20 \text{ }^\circ\text{C} \pm 5 \text{ }^\circ\text{C}$ at a constant current of 0,2 It A down to a specified final voltage	See page 2.	P
7.1.2	Second procedure		P
	This charging procedure applies only to 7.3.1, 7.3.4, 7.3.5, and 7.3.9		P

<b>JIS C 62133-2:2020</b>			
Clause	Requirement + Test	Result - Remark	Verdict
	After stabilization for 1 h and 4 h, respectively, at ambient temperature of highest test temperature and lowest test temperature, as specified in Table 2, cells are charged by using the upper limit charging voltage and maximum charging current, until the charging current is reduced to 0,05 It A, using a constant voltage charging method	Charge temperature specified by manufacturer: 10-45°C.	P
<b>7.2</b>	<b>Intended use</b>		P
7.2.1	Continuous charging at constant voltage (cells)	Tested complied.	P
	Fully charged cells are subjected for 7 days to a charge using the charging method for current and standard voltage specified by the cell manufacturer	Charging for 7days with 0.2C.	P
	Results: No fire. No explosion. No leakage..... :	(See appended table 7.2.1)	P
7.2.2	Case stress at high ambient temperature (battery)		P
	Oven temperature (°C)..... :	70°C	P
	Results: No physical distortion of the battery case resulting in exposure of internal protective components and cells	The shell showed no deformation	P
<b>7.3</b>	<b>Reasonably foreseeable misuse</b>		P
7.3.1	External short-circuit (cell)	Tested complied.	P
	The cells were tested until one of the following occurred:		P
	- 24 hours elapsed; or		P
	- The case temperature declined by 20 % of the maximum temperature rise		P
	Results: No fire. No explosion..... :	(See appended table 7.3.1)	P
7.3.2	External short-circuit (battery)		P
	The batteries were tested until one of the following occurred:		P
	- 24 hours elapsed; or		P
	- The case temperature declined by 20 % of the maximum temperature rise		N/A
	In case of rapid decline in short circuit current, the battery pack remained on test for an additional one hour after the current reached a low end steady state condition		N/A
	A single fault in the discharge protection circuit conducted on one to four (depending upon the protection circuit) of the five samples before conducting the short-circuit test		P

<b>JIS C 62133-2:2020</b>			
Clause	Requirement + Test	Result - Remark	Verdict
	A single fault applies to protective component parts such as MOSFET, fuse, thermostat or positive temperature coefficient (PTC) thermistor	U1	P
	Results: No fire. No explosion..... :	(See appended table 7.3.2)	P
7.3.3	Free fall	Tested complied of Cell	P
	Results: No fire. No explosion	No fire. No explosion	P
7.3.4	Thermal abuse (cells)	Tested complied.	P
	Oven temperature (°C)..... :	130°C	—
	Results: No fire. No explosion	No fire. No explosion	P
7.3.5	Crush (cells)	Tested complied.	P
	The crushing force was released upon:		P
	- The maximum force of 13 kN ± 0,78 kN has been applied; or		P
	- An abrupt voltage drop of one-third of the original voltage has been obtained		N/A
	Results: No fire. No explosion..... :	(See appended table 7.3.5)	P
7.3.6	Over-charging of battery		P
	The supply voltage which is:		P
	- 1,4 times the upper limit charging voltage presented in Table A.1 (but not to exceed 6,0 V) for single cell/cell block batteries or	1S2P	P
	- 1,2 times the upper limit charging voltage resented in Table A.1 per cell for series connected multi-cell batteries, and		N/A
	- Sufficient to maintain a current of 2,0 It A throughout the duration of the test or until the supply voltage is reached		P
	Test was continued until the temperature of the outer casing:		P
	- Reached steady state conditions (less than 10 °C change in 30-minute period); or		P
	- Returned to ambient		N/A
	Results: No fire. No explosion..... :	(See appended table 7.3.6)	P
7.3.7	Forced discharge (cells)	Tested complied.	P
	If the discharge voltage reaches the negative value of upper limit charging voltage within the testing duration, the voltage is maintained at the negative value of the upper limit charging voltage by reducing the current for the remainder of the testing duration		P

JIS C 62133-2:2020			
Clause	Requirement + Test	Result - Remark	Verdict
	If the discharge voltage does not reach the negative value of upper limit charging voltage within the testing duration, the test is terminated at the end of the testing duration		N/A
	Results: No fire. No explosion..... :	(See appended table 7.3.7)	P
7.3.8	Mechanical tests (batteries)		P
7.3.8.1	Vibration		P
	Results: No fire, no explosion, no rupture, no leakage or venting..... :	(See appended table 7.3.8.1)	P
7.3.8.2	Mechanical shock		P
	Results: No leakage, no venting, no rupture, no explosion and no fire..... :	(See appended table 7.3.8.2)	P
7.3.9	Design evaluation – Forced internal short-circuit (cells)	Tested complied.	P
	The cells complied with national requirement for..... :		—
	The pressing was stopped upon:		P
	- A voltage drop of 50 mV has been detected; or		N/A
	- The pressing force of 800 N (cylindrical cells) or 400 N (prismatic cells) has been reached	400N cylindrical cells	P
	Results: No fire..... :	(See appended table 7.3.9)	P

<b>8</b>	<b>INFORMATION FOR SAFETY</b>		P
<b>8.1</b>	<b>General</b>		P
	Manufacturers of secondary cells ensure that information is provided about current, voltage and temperature limits of their products	Information for safety mentioned in manufacturer's specifications.	P
	Manufacturers of batteries ensure that equipment manufacturers and, in the case of direct sales, end-users are provided with information to minimize and mitigate hazards	Information for safety mentioned in manufacturer's specifications.	P
	Systems analyses performed by device manufacturers to ensure that a particular battery design prevents hazards from occurring during use of a product		N/A
	As appropriate, any information relating to hazard avoidance resulting from a system analysis provided to the end user		N/A
	Do not allow children to replace batteries without adult supervision		N/A
<b>8.2</b>	<b>Small cell and battery safety information</b>	Not small battery	N/A

JIS C 62133-2:2020			
Clause	Requirement + Test	Result - Remark	Verdict
	The following warning language is to be provided with the information packaged with the small cells and batteries or equipment using them:		N/A
	- Keep small cells and batteries which are considered swallowable out of the reach of children		N/A
	- Swallowing may lead to burns, perforation of soft tissue, and death. Severe burns can occur within 2 h of ingestion		N/A
	- In case of ingestion of a cell or battery, seek medical assistance promptly		N/A

<b>9</b>	<b>MARKING</b>		P
<b>9.1</b>	<b>Cell marking</b>	The final product is battery	N/A
	Cells marked as specified in IEC 61960, except coin cells		N/A
	Coin cells whose external surface area is too small to accommodate the markings on the cells show the designation and polarity		N/A
	By agreement between the cell manufacturer and the battery and/or end product manufacturer, component cells used in the manufacture of a battery need not be marked		N/A
<b>9.2</b>	<b>Battery marking</b>		P
	Batteries marked as specified in IEC 61960, except for coin batteries	See marking plate on page 3.	P
	Coin batteries whose external surface area is too small to accommodate the markings on the batteries show the designation and polarity. Batteries also marked with an appropriate caution statement	Not coin battery	N/A
	Terminals have clear polarity marking on the external surface of the battery		P
	Batteries with keyed external connectors designed for connection to specific end products need not be marked with polarity markings if the design of the external connector prevents reverse polarity connections	Special designed connector used. Also the connector construction designed wrong polarity insert prevented.	P
<b>9.3</b>	<b>Caution for ingestion of small cells and batteries</b>	Not small battery.	N/A
	Coin cells and batteries identified as small batteries according to 8.2 include a caution statement regarding the hazards of ingestion in accordance with 8.2		N/A

JIS C 62133-2:2020			
Clause	Requirement + Test	Result - Remark	Verdict
	When small cells and batteries are intended for direct sale in consumer-replaceable applications, caution for ingestion given on the immediate package		N/A
<b>9.4</b>	<b>Other information</b>		P
	Storage and disposal instructions	Information for storage and disposal instructions mentioned in manufacturer's specifications.	P
	Recommended charging instructions	Information for recommended charging instructions mentioned in manufacturer's specifications.	P

<b>10</b>	<b>PACKAGING AND TRANSPORT</b>		P
	Packaging for coin cells not small enough to fit within the limits of the ingestion gauge of Figure 3		N/A
	The materials and packaging design are chosen so as to prevent the development of unintentional electrical conduction, corrosion of the terminals and ingress of environmental contaminants		P

<b>ANNEX A</b>	<b>CHARGING AND DISCHARGING RANGE OF SECONDARY LITHIUM ION CELLS FOR SAFE USE</b>		P
<b>A.1</b>	<b>General</b>		P
<b>A.2</b>	<b>Safety of lithium ion secondary battery</b>		P
<b>A.3</b>	<b>Consideration on charging voltage</b>	Complied.	P
A.3.1	General		P
A.3.2	Upper limit charging voltage	4.2V	P
A.3.2.1	General		P
A.3.2.2	Explanation of safety viewpoint		P
A.3.2.3	Safety requirements, when different upper limit charging voltage is applied	4.2V applied.	P
<b>A.4</b>	<b>Consideration of temperature and charging current</b>		P
A.4.1	General		P
A.4.2	Recommended temperature range	See A.4.2.2.	P
A.4.2.1	General		P
A.4.2.2	Safety consideration when a different recommended temperature range is applied	Charging temperature declared by client is: 0~55°C	P

JIS C 62133-2:2020			
Clause	Requirement + Test	Result - Remark	Verdict
A.4.3	High temperature range		N/A
A.4.3.1	General		N/A
A.4.3.2	Explanation of safety viewpoint		N/A
A.4.3.3	Safety considerations when specifying charging conditions in the high temperature range		N/A
A.4.3.4	Safety considerations when specifying a new upper limit in the high temperature range	45°C applied.	N/A
A.4.4	Low temperature range		P
A.4.4.1	General		P
A.4.4.2	Explanation of safety viewpoint		P
A.4.4.3	Safety considerations, when specifying charging conditions in the low temperature range		P
A.4.4.4	Safety considerations when specifying a new lower limit in the low temperature range	10°C applied	P
A.4.5	Scope of the application of charging current		P
A.4.6	Consideration of discharge		P
A.4.6.1	General		P
A.4.6.2	Final discharge voltage and explanation of safety viewpoint	3V specified by cell manufacturer.	P
A.4.6.3	Discharge current and temperature range		P
A.4.6.4	Scope of application of the discharging current		P

JIS C 62133-2:2020			
Clause	Requirement + Test	Result - Remark	Verdict

--	TABLE: Critical components information				P
Object/part no.	Manufacturer/ trademark	Type/model	Technical data	Standard	Mark(s) of conformity <sup>1)</sup>
Cell	Shenzhen Liangtou Technology Co., Ltd	1260110	3.7V, 23000mAh	J62133- 2(2021)( JI S C 62133- 2:2020)	Tested with Battery
-Electrolyte	--	--	--	--	--
-Separator	--	--	--	--	--
-Positive electrode	--	--	--	--	--
-Negative electrode	--	--	--	--	--
--	--	--	--	--	--
--	--	--	--	--	--
--	--	--	--	--	--
--	--	--	--	--	--
--	--	--	--	--	--
<b>Supplementary information:</b>					
<sup>1)</sup> Provided evidence ensures the agreed level of compliance.					

7.2.1	TABLE: Continuous charging at constant voltage (cells)				P
Sample no.	Recommended charging voltage V <sub>c</sub> (Vdc)	Recommended charging current I <sub>rec</sub> (A)	OCV before test (Vdc)	Results	
Cell #1	4.20	4.6	4.19	P	
Cell #2	4.20	4.6	4.17	P	
Cell #3	4.20	4.6	4.18	P	
Cell #4	4.20	4.6	4.17	P	
Cell #5	4.20	4.6	4.18	P	
<b>Supplementary information:</b>					
- No fire or explosion					
- No leakage					

7.3.1	TABLE: External short-circuit (cell)				P
Sample no.	Ambient T (°C)	OCV before test (Vdc)	Resistance of circuit (mΩ)	Maximum case temperature rise ΔT, °C	Results
<b>Samples charged at charging temperature upper limit (45°C)</b>					
Cell #6	55	4.18	80	98.5	P
Cell #7	55	4.17	80	99.4	P
Cell #8	55	4.17	80	98.2	P
Cell #9	55	4.19	80	100.2	P
Cell #10	55	4.18	80	101.8	P
<b>Samples charged at charging temperature lower limit (10°C)</b>					
Cell #11	55	4.14	80	94.7	P
Cell #12	55	4.15	80	88.2	P
Cell #13	55	4.15	80	96.8	P
Cell #14	55	4.14	80	95.4	P
Cell #15	55	4.13	80	89.8	P
<b>Supplementary information:</b>					
- No fire or explosion					

7.3.2		TABLE: External short-circuit (battery)					P
Sample no.	Ambient T (°C)	OCV before test (Vdc)	Resistance of circuit (mΩ)	Maximum case temperature rise $\Delta T$ , °C	Component single fault condition	Results	
Battery #1	24.6	5.16	80	38.8	U1	P	
Battery #2	24.4	5.16	80	42.4	U1	P	
Battery #3	24.3	5.14	80	41.5	U1	P	
Battery #4	24.2	5.14	80	38.2	U1	P	
Battery #5	24.5	5.15	80	23.5	--	P	
<b>Supplementary information:</b>							
- No fire or explosion							

7.3.5		TABLE: Crush (cells)			P
Sample no.	OCV before test (Vdc)	OCV at removal of crushing force (Vdc)	Maximum force applied to the cell during crush (kN)	Results	
<b>Samples charged at charging temperature upper limit (45°C)</b>					
Cell #16	4.18	4.18	13.1	P	
Cell #17	4.19	4.18	13.5	P	
Cell #18	4.19	4.19	13.3	P	
Cell #19	4.17	4.17	13.4	P	
Cell #20	4.19	4.18	13.5	P	
<b>Samples charged at charging temperature lower limit (10°C)</b>					
Cell #21	4.15	4.15	13.6	P	
Cell #22	4.14	4.14	13.3	P	
Cell #23	4.14	4.13	13.2	P	
Cell #24	4.15	4.14	13.3	P	
Cell #25	4.13	4.13	13.0	P	
<b>Supplementary information:</b>					
- No fire or explosion					

Sample no.	OCV before charging (Vdc)	Total charging time (minute)	Maximum outer case temperature (°C)	Results
Battery #6	4.22	120	38.9	P
Battery #7	4.18	120	40.2	P
Battery #8	4.19	120	41.6	P
Battery #9	4.20	120	39.4	P
Battery #10	4.21	120	39.7	P

**Supplementary information:**  
- No fire or explosion

Sample no.	OCV before application of reverse charge (Vdc)	Measured reverse charge $I_r$ (A)	Lower limit discharge voltage (Vdc)	Results
Cell #26	3.17	23	-4.2	P
Cell #27	3.19	23	-4.2	P
Cell #28	3.18	23	-4.2	P
Cell #29	3.15	23	-4.2	P
Cell #30	3.16	23	-4.2	P

**Supplementary information:**  
- No fire or explosion

Sample no.	OCV before test (Vdc)	OCV after test (Vdc)	Mass before test (g)	Mass after test (g)	Results
Battery #11	5.16	5.15	434.07	434.07	P
Battery #12	5.15	5.15	434.24	434.24	P
Battery #13	5.15	5.15	434.75	434.74	P

**Supplementary information:**  
- No fire or explosion  
- No rupture  
- No leakage  
- No venting

7.3.8.2		TABLE: Mechanical shock				P
Sample no.	OCV before test (Vdc)	OCV after test (Vdc)	Mass before test (g)	Mass after test (g)	Results	
Battery #14	5.15	5.14	434.56	434.56	P	
Battery #15	5.16	5.16	434.18	434.18	P	
Battery #16	5.16	5.16	434.35	434.34	P	
<b>Supplementary information:</b>						
- No fire or explosion - No rupture - No leakage - No venting						

7.3.9		TABLE: Forced internal short circuit (cells)				P
Sample no.	Chamber ambient T (°C)	OCV before test (Vdc)	Particle location <sup>1)</sup>	Maximum applied pressure (N)	Results	
<b>Samples charged at charging temperature upper limit (45°C)</b>						
Cell #31	45	4.18	1	400	P	
Cell #32	45	4.17	1	400	P	
Cell #33	45	4.19	1	400	P	
Cell #34	45	4.19	1	400	P	
Cell #35	45	4.17	1	400	P	
<b>Samples charged at charging temperature lower limit (10°C)</b>						
Cell #36	10	4.14	1	400	P	
Cell #37	10	4.14	1	400	P	
Cell #38	10	4.13	1	400	P	
Cell #39	10	4.15	1	400	P	
Cell #40	10	4.13	1	400	P	
<b>Supplementary information:</b>						
<sup>1)</sup> Identify one of the following: 1: Nickel particle inserted between positive and negative (active material) coated area. 2: Nickel particle inserted between positive aluminium foil and negative active material coated area. - No fire or explosion						

型式の区分Type classification.....:  要素 Factor.....  単電池の形状Shape of secondary Cell...  単電池の電解質の種類Type of electrolyte in secondary cell 単電池の上限充電電圧Upper-limit charge voltage of secondary cell:  組電池の質量Weight of secondary battery	リチウムイオン蓄電池Rechargeable Li-ion Polymer Battery 区分Classification  <input type="checkbox"/> (1)円筒形のもの Cylindrical <input type="checkbox"/> (2)角形のものAngular <input checked="" type="checkbox"/> (3)その他のものOther  <input checked="" type="checkbox"/> (1)液体状のものLiquid state <input type="checkbox"/> (2)その他のものOther <input checked="" type="checkbox"/> (1)4.25 V以下のもの4.25 V or less <input type="checkbox"/> (2)4.25 V を超えるものMore than 4.25 V <input checked="" type="checkbox"/> (1)7 kg以下のもの7 kg or less <input type="checkbox"/> (2)7 kg を超えるものMore than 7 kg
電池ブロックの個数Number of battery blocks:	<input type="checkbox"/> (1)1 個のものSingle <input checked="" type="checkbox"/> (2)2 個以上のものMultiple
過充電の保護機能Overcharge protection	<input checked="" type="checkbox"/> (1)組電池で制御するもの Controlled by secondary battery <input type="checkbox"/> (2)組電池搭載機器又は充電器で制御するもの Controlled by equipment incorporating a secondary battery or a charger
用途Uses...	<input checked="" type="checkbox"/> (1)携帯機器用のものFor mobile equipment <input type="checkbox"/> (2)卓上機器用のものFor desktop equipment <input type="checkbox"/> (3)その他のものOther
組電池の種類Type of secondary battery	<input type="checkbox"/> (1)はんだ付けその他の接合方法により、容易に取り外すこと ができない状態で機械器具に固定して用いられるもの その他の 特 殊な構造のもの Those designed to fix to appliances by soldering or other joining methods so that it cannot be easily removed,or those having other special construction <input checked="" type="checkbox"/> (2)その他のものOther

JIS 62133-2:2020 - ATTACHMENT			
Clause	Requirement + Test	Result - Remark	Verdict
<b>ATTACHMENT TO TEST REPORT</b> <b>JIS 62133-2:2020</b> <b>JAPAN NATIONAL DIFFERENCES</b> SECONDARY CELLS AND BATTERIES CONTAINING ALKALINE OR OTHER NON-ACID ELECTROLYTES - SAFETY REQUIREMENTS FOR PORTABLE SEALED SECONDARY CELLS, AND FOR BATTERIES MADE FROM THEM, FOR USE IN PORTABLE APPLICATIONS - PART 2: LITHIUM SYSTEMS			
<b>Differences according to</b> .....: J62133-2(2021)			
<b>TRF template used:</b> .....: IECEE OD-2020-F3, Ed. 1.1			
<b>Attachment Form No</b> .....: JP_ND_JIS 62133-2:2020 <b>Attachment Originator</b> .....: Japan Electrical Safety and Environment Technology Laboratories (JET) <b>Master Attachment</b> .....: Date 2022-08-23			
<b>Copyright © 2022 IEC System for Conformity Testing and Certification of Electrical Equipment (IECEE), Geneva, Switzerland. All rights reserved.</b>			
<b>National Differences</b>			
<b>4</b>	<b>PARAMETER MEASUREMENT TOLERANCES</b>		<b>P</b>
	e) $\pm 0.1$ mm for dimension		P
	f) $\pm 1$ % for capacity <sup>1)</sup> . Note <sup>1)</sup> : Capacity is expressed as the product of current and time.		P
<b>5</b>	<b>GENERAL SAFETY CONSIDERATIONS</b>		<b>P</b>
5.2	Internal wiring and insulation <u>shall</u> be sufficient to withstand the maximum anticipated current, voltage and temperature requirements.		P
	The orientation of wiring <u>shall</u> be such that adequate clearances and creepage distances are maintained between conductors.		P
	The mechanical integrity of internal connections <u>shall</u> be sufficient to accommodate conditions of <u>intended use</u> .		P
5.4	Cell manufacturers shall be provided with specifications and charging instructions for battery manufacturers so that specified chargers are designed to maintain charging within the temperature, voltage and current limits specified.	Complied.	P

JIS 62133-2:2020 - ATTACHMENT			
Clause	Requirement + Test	Result - Remark	Verdict
5.6.1	Each battery <u>shall</u> have an independent control and protection for current, voltage, temperature and any other parameter required for safety and to maintain the cells within their operating region.	Complied.	P
5.6.2	Design recommendation		P
	The voltage of each cell, or each cellblock consisting of parallel-connected plural cells, <u>shall</u> not exceed the upper limit of the charging voltage specified in Table 2, <u>where the portable electronic devices or similar devices have the function to limit the charging voltage of each cell or cellblock below the upper limit, the devices shall be inspected that the charging voltage is not exceeded the upper limit.</u>		P
	<u>The requirements and recommendations for secondary battery designer are follows.</u>		P
	<ul style="list-style-type: none"> <li>For the battery consisting of a single cell or a single cellblock, <u>the charging voltage of the cell shall</u> not exceed the upper limit of the charging voltage specified in Table 2;</li> </ul>		P
	<ul style="list-style-type: none"> <li>For the battery consisting of series-connected plural single cells or series-connected plural cellblocks, <u>the voltages of any one of the single cells or single cellblocks shall</u> not exceed the upper limit of the charging voltage, specified in Table 2, by monitoring the voltage of every single cell or the single cellblocks.</li> </ul>	Single cell battery	N/A
	<ul style="list-style-type: none"> <li>For the battery consisting of series-connected plural single cells or series-connected plural cellblocks, <u>charging shall be</u> stopped when the upper limit of the charging voltage is exceeded for any one of the single cells or single cellblocks by measuring the voltage of every single cell or the single cellblocks.</li> </ul>	Single cell battery	N/A
	<ul style="list-style-type: none"> <li>For batteries consisting of series-connected cells or cell blocks, nominal charge voltage shall not be counted as an overcharge protection.</li> </ul>		N/A
	<ul style="list-style-type: none"> <li>For batteries consisting of series-connected cells or cell blocks, cells should have closely matched capacities, be of the same design, be of the same chemistry and be from the same manufacturer.</li> </ul>	Single cell battery	N/A

JIS 62133-2:2020 - ATTACHMENT			
Clause	Requirement + Test	Result - Remark	Verdict
	<ul style="list-style-type: none"> <li>It is recommended that the cells and cell blocks should not be discharged beyond the cell manufacturer's specified final voltage.</li> </ul>		P
	<ul style="list-style-type: none"> <li>For batteries consisting of series-connected cells or cell blocks, cell balancing circuitry should be incorporated into the battery management system.</li> </ul>	Single cell battery	N/A
5.6.3A	Prevention of Harm from Sharp Corners		
	Cells and batteries shall not have any rough or sharp corners that can cause harm in their intended use, unless necessary for their function.		P
	If such corners are necessary for the function of the containers, connections, etc. of cells and batteries, structural protection measures shall be taken to prevent the user (consumer) from touching them.		P
	However, in the case of cells or specially constructed batteries that are not intended to be handled by users (consumers), measures may be taken by agreement between the delivering parties.		P
<b>6</b>	<b>TYPE TEST AND SAMPLE SIZE</b>		P
	Coin cells with internal resistance greater than 3 $\Omega$ are not required to be tested.		P
<b>7</b>	<b>SPECIFIC REQUIREMENTS AND TESTS</b>		P
7.0A	The test is performed on the number of cells or batteries specified in Table 1. The test temperature conditions are as specified in each test item in Clause 7. However, these tests may be performed under harsh conditions or methods that make the test results severe. In addition, cells and batteries are tested for each model. However, if a part of the structure of the battery is changed and the test result before the change can be substituted, the test specified in this clause may be omitted.		P
7.1.0A	The first procedure and the second procedure are specified as the charging procedure for performing the test. However, these charging procedures do not apply to 7.3.6, 7.3.7, 7.3.8B and 7.3.8D where the charging process is the purpose of the test.		P
7.1.1	This charging procedure applies to 7.2.1, 7.2.2, 7.2.2A, 7.3.2, 7.3.3, 7.3.8.1, 7.3.8.2, 7.3.8A and 7.3.8C.		P

JIS 62133-2:2020 - ATTACHMENT			
Clause	Requirement + Test	Result - Remark	Verdict
7.1.2	Upper limit charging voltage: 4.25 V/cell		P
	Upper limit test temperature: 45 °C		P
	Lower limit test temperature: 10 °C		P
	In case of new application or modification of the upper limit charging voltage, upper limit test temperature or lower limit test temperature, cell Manufacturer shall keep the relevant documents according to the procedure specified in Annex A. And the relevant value shall be applied as the upper limit charging voltage, upper limit test temperature or lower limit test temperature.		P
7.2.1	Replace item b) as following:		P
	b) Test Fully charged cells, according to the first procedure in 7.1.1, are subjected for <u>28 days</u> to a charge using <u>the upper limit charging voltage and upper limit test temperature.</u>		P
7.2.2A	Temperature cycle		P
	a) Requirement Repeated exposure of cells and batteries to high and low temperatures shall not cause fire, explosion, or leakage.		P
	b) Test Fully charged cells or batteries, according to the first procedure in 7.1.1, are subjected the temperature cycling of-20°C to 75 °C in the chamber(s), according to following procedure and the temperature profile shown in Figure 0A.		P
	1) cells or batteries are maintained in the ambient temperature of 75 °C ± 2 °C for 4 hours;		P
	2) the ambient temperature is changed to 20 °C ± 5 °C within 30 minutes, and maintain for at least 2 hours;		P
	3) the ambient temperature is changed to -20 °C ± 2 °C within 30 minutes, and maintain for 4hours;		P
	4) the ambient temperature is changed to 20 °C ± 5 °C within 30 minutes, and maintain for at least 2 hours;		P
	5) The steps from 1) to 4) are as one cycle, and repeat 4 more cycles. The transition time from 4) to 1) is within 30 minutes;		P

JIS 62133-2:2020 - ATTACHMENT			
Clause	Requirement + Test	Result - Remark	Verdict
	6) after the 5th cycle, cells or batteries are maintained in the ambient temperature of 20 °C ± 5 °C for 7days, and then checked by visual inspection.		P
	c) Acceptance criteria No fire, no explosion, no leakage	No fire, No explosion, No leakage.	P
7.3.1	Replace "20 %" with "80 %" in item b).		P
7.3.2	a) This requirement does not apply to the specially constructed batteries.		N/A
	Replace "20 %" with "80 %" in item b).		P
7.3.3	a) This requirement does not apply to the batteries with a mass exceeding 7 kg or the specially constructed batteries.		N/A
7.3.6	a) This requirement does not apply to the specially constructed batteries.		P
7.3.8.1	a) This requirement does not apply to the specially constructed batteries.		P
	c) No fire, no explosion, no leakage.		P
7.3.8.2	a) This requirement does not apply to the specially constructed batteries.		P
	b) For wave form, peak acceleration and pulse duration, see JIS C 60068-2-27.		P
	c) There shall be no leakage, no explosion and no fire during this test.		P
7.3.8A	Low pressure (cells)		P
	a) Requirement Low pressure (e.g. in case of air transport) shall not cause leakage, fire or explosion.		P
	b) Test Fully charged cells, according to the first procedure in 7.1.1, are placed in the vacuum chamber at an ambient temperature of 20 °C ± 5 °C. After closing the chamber, the pressure shall be gradually reduced to an internal pressure of 11.6 kPa (equivalent to an altitude of 15 240 m) or less, and kept this pressure for 6 hours. After the test, conduct a visual inspection.	11.6 kPa,6h	P
	c) Acceptance criteria No fire, no explosion, no leakage.	No fire, No explosion, No leakage.	P
7.3.8B	High rate charge (cells)		P

**JIS 62133-2:2020 - ATTACHMENT**

Clause	Requirement + Test	Result - Remark	Verdict
	a) Requirement Excessive current flow in the batteries with cell connected in parallel as result of battery charger failure shall not cause fire or explosion of cells. In case of the protective device is provided in the devices or batteries which the cell is used, the cell may be tested with the protective device.		P
	b) Test Test is conducted at upper limit test temperature and lower limit test temperature. Discharged cell shall be fully charged at a charging current of 3 times the maximum charging current. In case of the protective device is provided in the corresponding device or battery, and the protective device operate before being fully charged, test is conducted until the protective device operates and interrupts the charging current.		P
	c) Acceptance criteria No fire, no explosion.	No fire, no explosion.	P
7.3.8C	Free fall of battery installed in the device (batteries)		P
	a) Requirement Free fall with the battery installed in a load equivalent to the maximum mass of the device to which it is installed shall not cause an external short circuit inside the battery, nor shall it cause an internal short circuit in the cells inside the battery.		P

JIS 62133-2:2020 - ATTACHMENT			
Clause	Requirement + Test	Result - Remark	Verdict
	b) Test Fully charged batteries, according to the first procedure in 7.1.1, are installed in a portable device intended for use or simulated to be installed, and dropped once from the drop test height specified in JIS C 6950-1 or JIS C 6065, depending on the intended use, onto a concrete floor in a direction that is the most adverse effect on the batteries, or subjected to an equivalent load. The floor to drop the batteries can be a metal plate instead of the concrete floor. For test conditions where optional parts can be attached to the device, the test shall be performed with the optional parts specified by the manufacturer that are required for the basic operation of the device (excluding those connected by cords). If there are multiple combinations of optional parts, the test shall be conducted with the combination that gives the most favourable test results.		N/A
	The drop test height is in accordance with 4.2.6 of JIS C 6950-1 and 12.1.5 of JIS C 6065. However, this is not applicable to the devices that the mass of the device with the battery is greater than 7 kg for portable devices and 5 kg for desktop devices (excluding the device may be portable). This test allows with the batteries installed in the equivalent load to the device that intended to be used. For example, if a minor change product (series product) of a certain device installed a battery of the same design, and the battery is tested with a load equivalent to the device, and the test conditions meet the test conditions for all series products, there is no need to conduct the test again.		P
	Mass of the device with the battery (kg) .....		—
	Drop height (mm).....	1.0mm	—
	c) Acceptance criteria No external short circuit inside the battery, no internal short circuit in the cells inside the battery.		P
7.3.8D	Protection against overcharge (batteries)		P

**JIS 62133-2:2020 - ATTACHMENT**

Clause	Requirement + Test	Result - Remark	Verdict
	<p>a) Requirement</p> <p>The charge voltage of a cell or a cell block with cells connected in parallel in a battery shall not exceed the upper limit charging voltage specified in Table 2, regardless of the parameter measurement tolerances. This test is not applicable where the device or other controls the charging voltage so that it does not exceed the upper limit charging voltage.</p>		P
	<p>b) Test</p> <p>The test is conducted at an ambient temperature of <math>20\text{ }^{\circ}\text{C} \pm 5\text{ }^{\circ}\text{C}</math> by one of the methods of following 1) to 3). The examples of circuit configuration of the test for over charge protection are shown in Figure 1A. However, since this circuit configuration is only an example, the actual test may be conducted with the test method determined in advance between the battery manufacturer and the testing engineer. The purpose of this test is to verify that adequate overcharge protection is provided as a control for the battery, and the overcharge protection may be provided in the battery or in the device in which the battery is installed or the battery charger.</p>		P
	<p>1) For the battery consists of a single cell or a single cell block, the voltage applied to the cell or cell block during charging is measured.</p>		P
	<p>2) For the battery consists of two or more cells or cell blocks connected in series, charging is performed while measuring the voltage of each cell or cell block, and at the same time a single cell or cell block is gradually forced to discharge, and the voltage of each other cell or cell block is measured.</p>		N/A
	<p>3) For the battery consists of two or more cells or cell blocks connected in series, the voltage is applied to a single cell or cell block until the upper charging voltage in Table 2 is exceeded while measuring the voltage of each cell or cell block, and the voltage when charging stops is measured.</p>		N/A

JIS 62133-2:2020 - ATTACHMENT			
Clause	Requirement + Test	Result - Remark	Verdict
	c) Acceptance criteria The measured voltage shall not exceed the upper limit charging voltage. However, voltage fluctuations (e.g., voltage fluctuations of AC components above 50 kHz assuming ripple, noise, etc.) that are not followed by lithium-ion migration in the battery is excluded.		P
7.3.9	Forced internal short-circuit (cells)		P
	This sub-clause is not applicable to coin cells and lithium ion polymer cells.		P
	a) A forced internal short-circuit test for <u>cells</u> shall not cause a fire.		P
	b) Test 1) Number of samples This test shall be carried out until the total number of samples with observed internal short-circuits reaches 5. However, when the number of samples tested reaches 10, the test shall be terminated even if the total number of samples with observed internal short-circuits does not reach 5. For the test each at the upper limit test temperature and lower limit test temperature, 5 to 10 samples each with a nickel particle placed between the positive active material area and the negative active material area shall be prepared. In addition, when aluminium foil of positive electrode is exposed at outer turn and the aluminium foil is facing the coated negative active material, for the test each at the upper limit test temperature and lower limit test temperature, 5 to 10 samples each with a nickel particle placed at that area shall be prepared.		P
<b>8</b>	<b>INFORMATION FOR SAFETY</b>		P
8.2	This is not applicable to specially constructed batteries that cannot be removed by user.		P
	Equipment using small cells and batteries should be provided with information regarding ingestion hazards.		N/A
	The warning language should be provided with the information packaged with the small cells and batteries, and equipment using them:		N/A
<b>9</b>	<b>MARKING</b>		P

JIS 62133-2:2020 - ATTACHMENT			
Clause	Requirement + Test	Result - Remark	Verdict
9.1	By agreement between the cell manufacturer and the battery and/or end product manufacturer, component cells used in the manufacture of a battery need not be marked. However, the cell markings shall be indicated with the battery, the instructions or the specifications.		P
<b>10</b>	<b>PACKAGING AND TRANSPORT</b>		P
	Replace "Packaging for coin cells" with "Packaging for coin cells and small batteries".		P
<b>A</b>	<b>ANNEX A (NORMATIVE) CHARGING AND DISCHARGING RANGE OF SECONDARY LITHIUM ION CELLS FOR SAFE USE</b>		P
A.2	In case of a different upper limit charging voltage (other than 4.25 V of lithium-cobalt-oxide system), it may be appropriate to adjust the upper limit charging voltage and upper limit charging temperatures accordingly to fulfil the criteria of the tests.		P
A.3.2.1	In this battery, the upper limit charging voltage, as specified in 7.1.2 is based on the permissible upper limit charging voltage (4.25 V) from a safety viewpoint.		P
A.3.2.2	Replace "should" with "shall" in 3rd paragraph.		P
A.3.2.3	Safety requirements, when different upper limit charging voltage is applied		P
	The upper limit charging voltage of a lithium ion secondary cell could be other than 4.25 V in the following cases:		P
	• positive active material, other than lithium-cobalt- oxide is employed;		P
	• ratio of the capacity of the positive electrode and the negative electrode is changed from the design viewpoint		P
	When an upper limit charging voltage different from 4.25 V is to be applied for lithium ion secondary cells, following relevant documents explaining reasons for the change of upper limit charging voltage shall be kept so that said different voltage can be used as the new upper limit charging voltage.		N/A

JIS 62133-2:2020 - ATTACHMENT			
Clause	Requirement + Test	Result - Remark	Verdict
	a) test results which verify that the stability of the positive active material (including lithium-cobalt- oxide), the structural stability of the electrolyte, and the lithium acceptability of the negative active material of lithium secondary cells charged at the new upper charging voltage limit are as safe or safer than those of typical lithium secondary cells charged at 4.25 V;		N/A
	b) the following relevant documents explaining the reason for the change if it differs from the upper limit charge voltage specified in Table 2;		N/A
	1) test results which verify that lithium secondary cells charged at the new upper limit charging voltage and at a temperature 5 °C higher than the upper limit test temperature comply with the tests in 7.3.1, 7.3.4, 7.3.5, and 7.3.9 at a temperature 5 °C higher than the upper limit test temperature;		N/A
	2) test results which verify that lithium secondary cells charged at the new upper limit charge voltage and at a temperature 5 °C below the lower limit test temperature comply with the tests in 7.3.1, 7.3.4, 7.3.5, and 7.3.9 at a temperature 5 °C below the lower limit test temperature;		N/A
	3) test results which verify compliance of cells charged at the upper limit of the high temperature range of the test accordance with 7.3.1, 7.3.4, 7.3.5 and 7.3.9. The charging voltage and the charging current at the upper limit of the high temperature range are specified by the battery manufacturer.		N/A
A.4.2.1	Replace “the battery” with “the cell” .		P
A.4.2.2	Safety consideration when a different recommended temperature range is applied		P
	For lithium secondary cells, a temperature range other than 10 °C to 45 °C may be recommended, depending on the thermal stability of the electrolyte and other factors.		P
	When new standard temperature ranges are applied, the tests specified in 7.3.1, 7.3.4, 7.3.5 and 7.3.9 shall be carried out using batteries charged at different test temperatures.		P

JIS 62133-2:2020 - ATTACHMENT			
Clause	Requirement + Test	Result - Remark	Verdict
	However, if there are test results for cells specified in 7.3.1, 7.3.4, 7.3.5 and 7.3.9 attest temperatures higher than the new upper limit test temperature or attest temperatures lower than the new lower limit test temperature, the test of cells at the new upper or new lower limit test temperature using the same upper limit charging voltage as in these clauses 7.3.1, 7.3.4, 7.3.5 and 7.3.9 may be omitted. In addition, relevant documents explaining the reason for the change of the test temperature shall be kept to allow testing at different test temperatures.		P
	Examples of the documents, explaining reasons of the change of test temperature are as follows:		P
	a) For upper limit test temperature higher than the value specified in Table 2:		P
	1) test results which verify that the stability of the crystal structure of the positive active electrode material, when the cell is charged at the new upper limit of test temperature, higher than 45 °C (highest limit of the standard temperature range for typical lithium ion cells), is equivalent to or higher than that when the cell is charged at 45 °C;		P
	2) test results which verify that the cells, charged at the new upper limit of test temperature (higher than 45 °C + 5 °C) and by using the upper limit charging voltage, are tested by the test methods specified in 7.3.1, 7.3.4, 7.3.5 and 7.3.9;		N/A
	b) For lower limit test temperature lower than the value specified in Table 2:		P
	1) test results which verify that the acceptance of lithium into the negative active material, when the cell is charged at the new lower limit of test temperature, lower than 10 °C, is equivalent to or higher than that when the cell is charged at 10 °C;		N/A
	2) test results which verify that the cells, charged at the new lower limit of test temperature (lower than 10 °C to 5 °C) and by using the upper limit of charging voltage, are tested by the test methods specified in 7.3.1, 7.3.4, 7.3.5 and 7.3.9.	0°C	P
A.4.3.1	General		P

**JIS 62133-2:2020 - ATTACHMENT**

Clause	Requirement + Test	Result - Remark	Verdict
	Within the high temperature range, charging is permissible by charging at a lower value than the upper limit charging voltage and/or maximum charging current which is specified for the standard temperature range.		P
A.4.3.4	b) The charging voltage and the charging current for the test are specified by the battery manufacturer.		P
A.4.4.1	Replace "the battery" with "the cell" .		P
A.4.4.4	b) The charging voltage and the charging current for the test are specified by the battery manufacturer.		P
A.5.6	Replace "Figure A.7" with "Figure A.9".		P

7.2.2A	TABLE: Temperature cycle		P
Model	OCV at start of test, (Vdc)	Results	
Cell	4.18	P	
Cell	4.18	P	
Cell	4.19	P	
Cell	4.19	P	
Cell	4.17	P	
Battery	5.16	P	
Battery	5.14	P	
Battery	5.16	P	
Battery	5.15	P	
Battery	5.16	P	
supplementary information: A: No Fire B: No Explosion C: No Leakage			

**JIS 62133-2:2020 - ATTACHMENT**

Clause	Requirement + Test	Result - Remark	Verdict
<b>7.3.8.A</b>	<b>TABLE: Low pressure (cells)</b>		P
	Model	OCV at start of test, (Vdc)	Results
	Cell	4.19	P
	Cell	4.18	P
	Cell	4.18	P
supplementary information: A: No Fire B: No Explosion C: No Leakage			

<b>7.3.8.B</b>	<b>TABLE: High rate charge (cells)</b>			P	
	Model	OCV at start of test, (Vdc)	ambient temperature, °C	charging current (A)	Results
Samples charged at charging temperature upper limit:45°C					
	Cell	3.24	45	34.5	P
	Cell	3.20	45	34.5	P
	Cell	3.22	45	34.5	P
	Cell	3.19	45	34.5	P
	Cell	3.18	45	34.5	P
Samples charged at charging temperature lower limit:10°C					
	Cell	3.17	10	34.5	P
	Cell	3.18	10	34.5	P
	Cell	3.17	10	34.5	P
	Cell	3.16	10	34.5	P
	Cell	3.16	10	34.5	P
supplementary information: A: No Fire B: No Explosion C: No Leakage					

**JIS 62133-2:2020 - ATTACHMENT**

Clause	Requirement + Test	Result - Remark	Verdict
--------	--------------------	-----------------	---------

7.3.8.C	TABLE: Free fall of battery installed in the device (batteries)				P
Model	OCV at start of test, (Vdc)	Test times	Height(m)	Results	
Battery	5.16	--	1.0	P	
Battery	5.15	--	1.0	P	
Battery	5.16	--	1.0	P	

**Supplementary information:**

A: No Fire  
 B: No Explosion  
 C: No Leakage

**Photos**

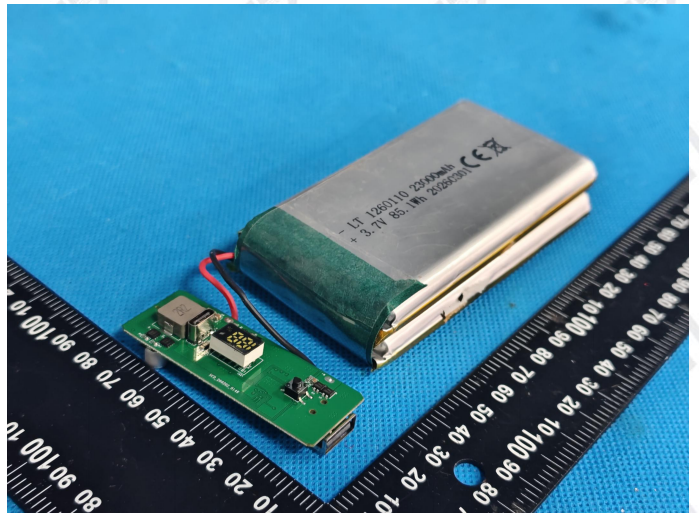
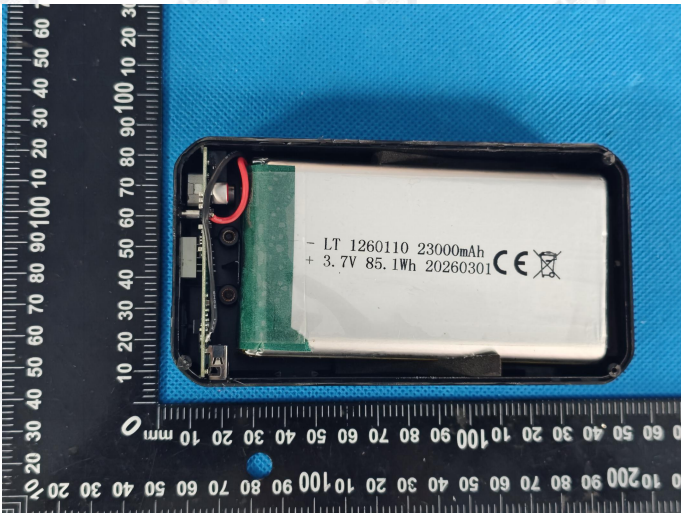
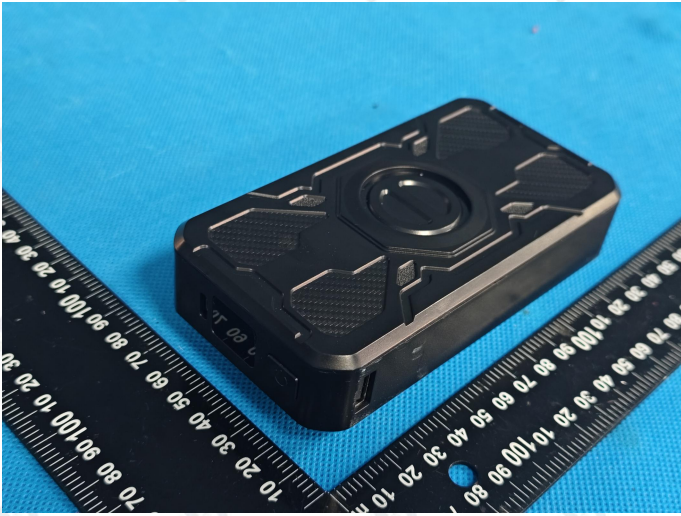

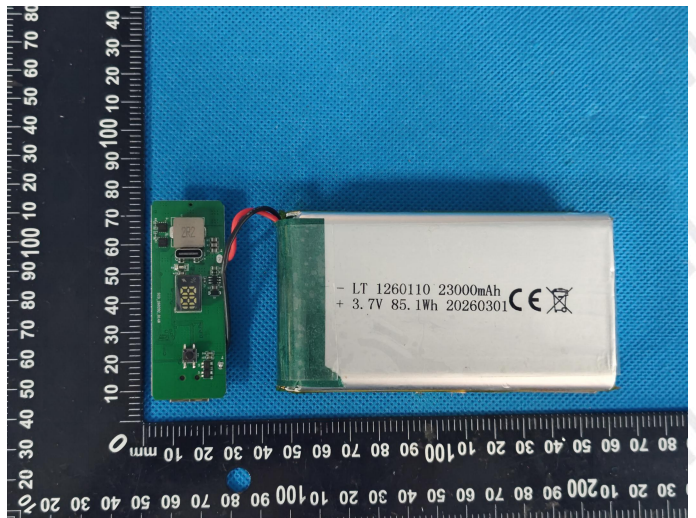
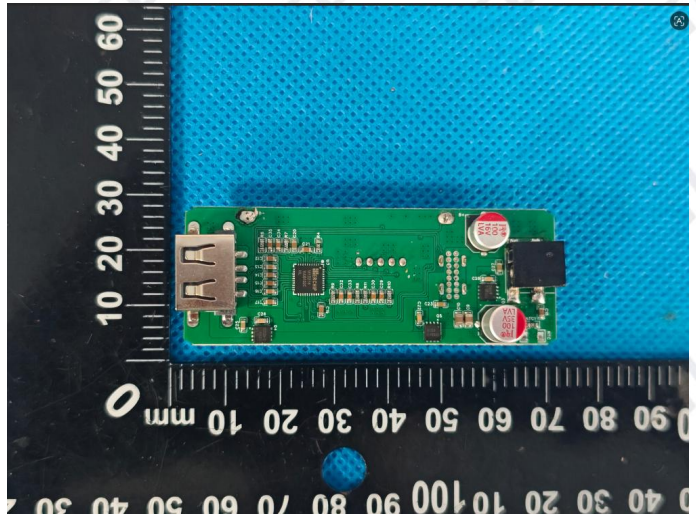
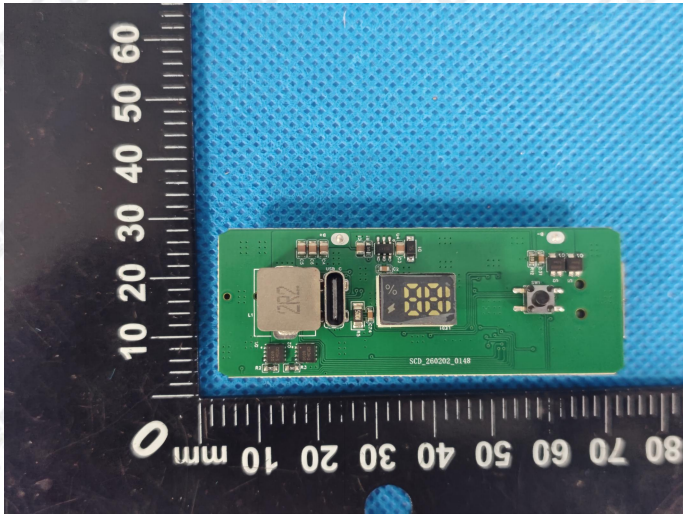

--- End of Report ---