



**TEST REPORT
UL 2056:2024 R2.25**

STANDARD FOR SAFETY Power Banks

Report Number..... : RHDTL260320039
Date of issue..... : 2026.04.10
Total number of pages..... : 39 pages
Applicant's name..... : RoyPow Technology Co., Ltd.
Address..... : RoyPow Industrial Park, No.16, Dongsheng South Road, Chenjiang Street, Zhongkai High-Tech District, Huizhou City, Guangdong Province, China
Manufacturer..... : RoyPow Technology Co., Ltd.
Address..... : RoyPow Industrial Park, No.16, Dongsheng South Road, Chenjiang Street, Zhongkai High-Tech District, Huizhou City, Guangdong Province, China
Trade Mark..... : ROYPOW
Test item description..... : Power Bank
Model/Type reference..... : C86
Ratings..... : 11.1V,7800mAh,86.58Wh
Test specification:
Standard..... : UL 2056:2024 R2.25
Test procedure..... : Test report
Responsible Testing Laboratory (as applicable), testing procedure and testing location(s):
Testing Laboratory..... : Dongguan HDTL Technology Co., Ltd.
Testing location/ address..... : Room 101, Building 1, No. 5 of Jinzhong Road, Dongcheng Street, Dongguan City, Guangdong Province, China.
Tested by (name + signature)..... : QiaoLi Chen *Qiao Li Chen*
Tested by (name, function, signature)..... : Brian Liu *Brian Liu*
Approved by (name, function, signature)..... : Chris zhao *Chris zhao*

Test item particulars:

Information about the product needed to establish a correct test program, such as product mobility, type of power connections and similar. (Test item particulars are selected by the TRF Originator base on the requirements in the standard)

Designation.....: Power Bank

Trademark.....: ROYPOW

Input rating.....: Input : USB-C:30W Max(PD30W: DC5V3A; DC9V3A; DC12V2.5A; DC15V2A; DC20V1.5A)

Output rating.....: Output: USB-C: PD30W: (DC5V3A; DC9V3A; DC12V2.5A; DC15V2A; DC20V1.5A)

USB-A1: QC3.0 18W(DC5V3A; DC9V2A; DC12V1.5A)
 USB-A2:DC 5V2.4A
 12VDCOUT:DC12V5A
 12V CIGAR OUT:DC12V10A

Output capacity.....: 11.1V,7800mAh,86.58Wh

Built-in battery rated capacity.....: 15000mAh(5V---3A)

Discharge cutoff voltage.....: 3V

Output capacity.....: 5V---3A

Ambient temperature range.....: 0~35°C (charge), -10~40°C (discharge)

Recommend charging method declared by the manufacturer.....: 3A constant current charge to 5.5V, then constant voltage 5.5V charge until charging current declines to 200mA at 20°C±5°C.

Sample number.....: B01~B41

Possible test case verdicts:

Test case does not apply to the test object.....: N(/A)

Test object does meet the requirement.....: P(ass)

Test object does not meet the requirement.....: F(ail)

Testing:

Date of receipt of test item.....: 2026.03.20

Date(s) of performance of tests.....: 2026.03.20 ~ 2026.04.10

General remarks:

This report shall not be reproduced, except in full, without the written approval of the testing laboratory.

The test results presented in this report relate only to the object tested.

"(see remark #)" refers to a remark appended to the report.

"(see appended table)" refers to a table appended to the report.

Throughout this report a point is used as the decimal separator.

Test clauses and results:

- cl.12 Short-Circuit of Output Port Test..... : P
- cl.13 Abnormal Charging of the Battery Test..... : P
- cl.14 Abusive Overcharge of the Battery Test..... : P
- cl.15 Forced-Discharge of the Cells Test..... : P
- cl.16 Temperature Test and BMS Verification..... : P
- cl.17 Power Input Test..... : P
- cl.18 Overload of Output Ports Test..... : P
- cl.19 Flammability of Photovoltaic Cells Test..... : N/A
- cl.20 Capacity Verification Test..... : P
- cl.22 Steady Uniform Force Test..... : P
- cl.23 Flexing Force Test..... : P
- cl.24 Mold Stress Relief Test..... : P
- cl.25 Drop Impact Test..... : P
- cl.26 Label Permanence Test..... : P

Copy of marking plate:

Product Name	: Power Bank
Model	: C86
specifications	11.1V 7800mAh 86.58Wh Rated Capacity: 3000mAh Input: USB-C:30W Max(PD30W: DC5V3A; DC9V3A; DC12V2.5A; DC15V2A; DC20V1.5A) Output :USB-C: PD30W: (DC5V3A; DC9V3A; DC12V2.5A; DC15V2A; DC20V1.5A)USB-A1: QC3.0 18W(DC5V3A; DC9V2A; DC12V1.5A)USB-A2:DC 5V2.4A 12VDCOUT: DC12V5A 12VCIGAR OUT: DC12V10A
Manufacturer	: RoyPow Technology Co., Ltd.
Manufacturer address	: RoyPow Industrial Park, No.16, Dongsheng South Road, Chenjiang Street, Zhongkai High-Tech District, Huizhou City, Guangdong Province, China

General product information and other remarks:

The product covered in this report is a Power Bank which is intended to use for mobile powering of low voltage electronic devices.

This Power Bank is constructed with 9 cell (3S3P) and has overcharge, over-discharge, over current and short-circuits proof circuit.

The Power Bank mainly composed of:

- Protective circuit module
- Li-ion cell (3S3P)
- Wiring
- Plastic enclosure

Power Bank electrical parameter:

Item	Component cell (for reference)	Power Bank
Model	INR18650V	C86
Rated capacity	2600mAh	7800mAh
Nominal voltage	3.7V	5V
Nominal charging current	520mA	USB-C:30W Max(PD30W: DC5V3A; DC9V3A; DC12V2.5A; DC15V2A; DC20V1.5A)
Nominal discharging current	520mA	USB-C: PD30W: (DC5V3A; DC9V3A; DC12V2.5A; DC15V2A; DC20V1.5A) USB-A1: QC3.0 18W(DC5V3A; DC9V2A; DC12V1.5A) USB-A2:DC 5V2.4A 12VDCOUT:DC12V5A 12VCIGAR OUT:DC12V10A
Maximum charging current	2600mA	USB-C:30W Max(PD30W: DC5V3A; DC9V3A; DC12V2.5A; DC15V2A; DC20V1.5A)
Maximum discharging current	5200mA	USB-C: PD30W: (DC5V3A; DC9V3A; DC12V2.5A; DC15V2A; DC20V1.5A) USB-A1: QC3.0 18W(DC5V3A; DC9V2A; DC12V1.5A) USB-A2:DC 5V2.4A 12VDCOUT:DC12V5A 12VCIGAR OUT:DC12V10A
Upper limit charging voltage	4.2V	--
End-of-discharge voltage	3.0V	--
Charge temperature range	0~45°C	0~45°C

Construction:

 Cell(INR18650V): Weight: 44.1g; Size: D*H = ϕ 18.1*65.2 (mm).

Battery(C86): Weight: 597.5g; Size:L*W*T =130.2*62.4*62.4 (mm).

Circuit diagram:

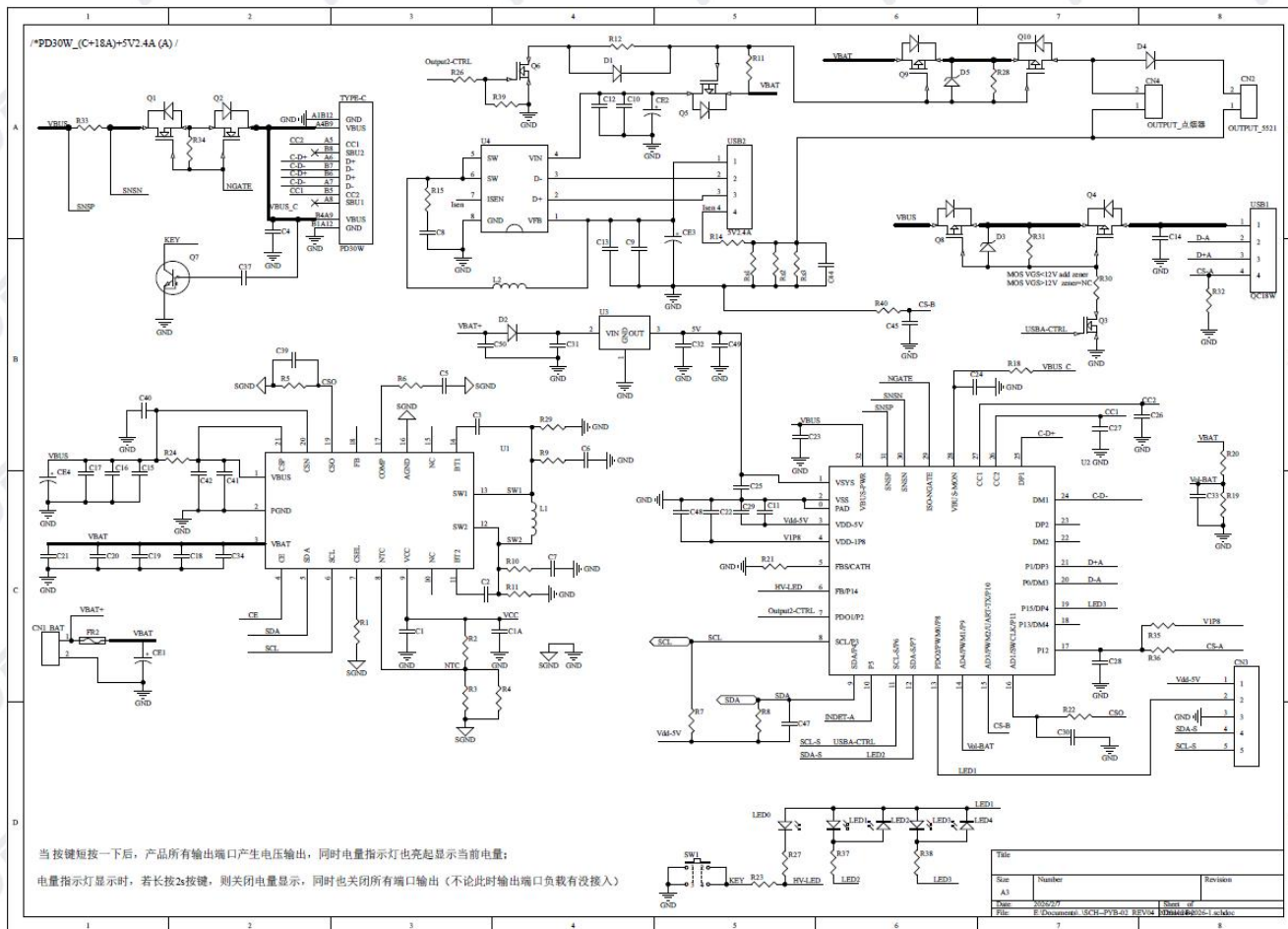

Factory:

RoyPow Technology Co., Ltd.

RoyPow Industrial Park, No.16, Dongsheng South Road, Chenjiang Street, Zhongkai High-Tech District, Huizhou City, Guangdong Province, China



UL 2056:2024			
Clause	Requirement + Test	Result - Remark	Verdict
CONSTRUCTION			
6	General		P
6.1	Casing and enclosure		P
6.1.1	The enclosure of a Power Bank shall have the strength and rigidity required to resist the reasonably foreseeable abuses, that it is exposed to during its reasonably foreseeable use, in order to reduce the risk of fire or injury to persons.		P
6.1.2	The enclosure of a Power Bank shall be rigid enough to prevent flexing that would result in damage to the cells or internal protective components. A tool providing the mechanical advantage of a plier, hacksaw, or similar tool, shall be the minimum mechanical capability required to open the Power Bank enclosure.	Complied.	P
6.1.3	For a Power Bank with a plastic outer enclosure, the outer enclosure shall be designed such that it is not capable of being opened using simple tools, such as a screwdriver. The enclosure shall be ultrasonically welded, or permanently secured by equivalent means. Adhesives complying with the adhesive requirements of UL 746C or CSA C22.2 No. 0.17, single use or tamper-proof screws are considered equivalent means.		N/A
6.1.4	All outer enclosure material of the Power Bank shall be classed as V-1 or less flammable (e.g. V-0, 5VB, 5VA) with its RTI temperature ratings in the minimum part thickness in accordance with UL 94 or CSA C22.2 No. 0.17. Enclosure material without suitable RTI temperature ratings but passing the glowwire test at 550 °C (1022 °F) according to IEC 60695-2-11 is acceptable as an alternative.		P
Exception	Materials are not required to be classed as V-1 or less flammable when they comply with the Enclosure Flammability – 20 mm (3/4 inch) Flame test described in UL 746C or CSA C22.2 No. 0.17.		P
6.1.5	Nonmetallic materials used for internal parts within the overall enclosure shall be rated V-2 minimum (e.g. V-2, V-1, V-0, 5VB, 5VA).		P
6.1.6	Small parts, and gaskets, that are not located near live parts, and are located in a manner such that they cannot propagate flame from one area to another within the equipment, are not required to have a specific flame rating.		P

UL 2056:2024			
Clause	Requirement + Test	Result - Remark	Verdict
6.1.7	No openings in Power Bank enclosures shall be permitted to prevent damage to cells, connections, and internal circuitry and shorting of electrical spacings within the pack.		P
Exception	Openings for power input/output and pressure venting are permitted. Enclosure openings are permitted to be located over cells that comply with the rigid casing requirements of 6.1.2 or over protective circuitry and connections where damage or shorting from debris entering the enclosure shall not result in a hazard.		P
6.2	Cells		
6.2.1	The lithium cell of a Power Bank shall comply with either UL 1642 or UL 62133-2 / CSA C22.2 No. 62133-2.		P
6.2.2	The nickel cell of a Power Bank shall comply with either UL 2054 or UL 62133-1 / CSA C22.2 No. 62133-1.		N/A
6.2.3	For other chemistry of cell types, the cell shall comply with the related safety standard requirements.		P
6.3	Wiring and terminals		P
6.3.1	Wiring shall be insulated and acceptable for the purpose, when considered with respect to temperature, current, and voltage to which the wiring is likely to be subjected within the Power Bank.	Complied.	P
6.3.2	All wiring connections shall be mechanically secured and shall provide electrical contact without strain on connections and terminals. Wiring shall be secured and routed away from sharp edges or other parts that may compromise wiring insulation.		P
6.3.3	Wiring splices and twist connectors shall not be permitted for Power Banks.		P
6.3.4	All electrical connections, such as splicing wire connectors, quick-connect terminals, terminal connectors, multi-pin and other forms of wire connectors, shall comply with the following standards: a) UL 310 / CSA C22.2 No. 153; b) UL 486A-486B / CSA C22.2 No. 65; c) UL 486C / CSA C22.2 No. 188;	Complied.	P

UL 2056:2024			
Clause	Requirement + Test	Result - Remark	Verdict
	d) UL 486E or CSA C22.2 No. 158 or CSA C22.2 No. 65; e) UL 1977 or CSA C22.2 No. 182.3.		
Exception	This requirement is not applicable to the following types of connections: a) Brazed or welded connections; b) Soldered connections on printed circuit boards; or c) Connections on small components that are mounted on printed circuit boards located in a low-voltage circuit.		P
6.4	External Power Bank connectors		P
6.4.1	An external Power Bank connector shall be constructed to prevent inadvertent short circuiting of its terminals. Examples of methods to prevent inadvertent short-circuiting include recessing the terminals, providing circuitry that prevents inadvertent short circuiting, providing covers over the terminals, use of keyed connectors, and the like.		P
6.4.2	Insulating material for external Power Bank connectors, outside the enclosure, shall have a V-2 minimum flame rating. External connectors forming part of the fire enclosure shall be V-1 minimum.		P
6.5	Printed wiring boards		P
6.5.1	Printed wiring boards with or without mounting circuit components shall be rated V-1 minimum and comply with UL 796.		P
6.6	Lithium ion systems only		P
6.6.1	The voltage and temperature of each cell or each cell block consisting of parallel-connected plural cells shall not exceed the upper limit charging voltage and temperature specified by the cell manufacturer.		N/A
6.6.2	For the Power Bank consisting of a single cell or a single cellblock, it shall be confirmed that the charging voltage and temperature of the cell does not exceed the upper limit charging voltage and temperature specified by the cell manufacturer.		P
6.6.3	For the Power Bank consisting of series-connected plural single cells or series-connected plural cellblocks, it shall be confirmed that the voltages and temperatures of any one of the single cells or single cellblocks do not exceed the upper limit charging voltage		N/A

UL 2056:2024			
Clause	Requirement + Test	Result - Remark	Verdict
	and temperature, specified by the cell manufacturer, by monitoring the voltage and temperature of every single cell or the single cellblocks.		
6.6.4	Compliance for 6.6.1 – 6.6.3 can be achieved through analysis of the battery protection circuit or if unable to determine through analysis, then through monitoring values during the test of Sections 14 and 16.		P
6.7	Direct plug-in construction		N/A
6.7.1	For Power Banks with direct plug-in construction, the following shall be met: a) The Power Bank and its built-in ac/dc power supply shall comply with the applicable requirements of UL 62368-1 / CSA C22.2 No. 62368-1. b) A barrier shall be provided between the built-in ac/dc power supply and built-in battery pack. The barrier shall comply with the requirements of electrical insulation and fire enclosure of UL 62368-1 / CSA C22.2 No. 62368-1. c) When the Power Bank is charged by an ac power source, the Power Bank shall not discharge.		N/A
6.8	Direct plug-in construction		N/A
6.8.1	The Power Bank that provides wireless charging or wireless discharging functions shall comply with the applicable requirements of UL 2738 or similar.		N/A
PERFORMANCE			
7	General		P
7.1	Power Banks are to be tested as described in Sections 12 – 26. The Forced-Discharge Test, Section 15, is applicable only to Power Banks with cells in multicell series applications.		P
7.2	Power Banks or their cells shall not explode or catch fire as a result of the tests in this Standard. For the Steady Uniform Force Test, Section 22, and the Drop Impact Test, Section 25, the samples shall also not separate. For the Steady Uniform Force Test, Section 22, Flexing Force Test, Section 23, Mold Stress Relief Test, Section 24, and the Drop Impact Test, Section 25, the samples shall also not vent or leak. For these tests, unacceptable leakage is deemed to have occurred when the resulting mass loss		P

UL 2056:2024			
Clause	Requirement + Test	Result - Remark	Verdict
	exceeds 0.1 %.		
7.3	Each output port shall be an ES1 energy source in accordance with UL 62368-1 / CSA C22.2 No.62368-1.		N/A
7.4	Unless indicated otherwise, the Power Banks are to be tested in an ambient temperature of 20 ± 5 °C (68 ± 9 °F).		
8	Protective Devices		P
8.1	<p>When a current-limiting component or temperature-limiting component that has been evaluated for the purpose (i.e. a positive temperature coefficient device complying with the tests specified in UL 1434 and UL 60730-1 or CSA C22.2 E60730-1, the Annex for Requirements for Thermistor Elements and Controls Using Thermistors, Annex J) activates as designed, testing shall be resumed as follows:</p> <p>a) A resettable device that operates during the test – The test is to be continued allowing the device to cycle during the test;</p> <p>b) A non-resettable device or resettable device that operates during the test but does not reset – The test is to be repeated with the battery pack connected to the maximum load that does not cause the protective device to trip; and</p> <p>c) A current-limiting or temperature-limiting device that has not been evaluated for the purpose is to be shorted from the circuit prior to testing.</p>		P
9	Samples		P
9.1	Unless otherwise indicated, Power Banks in the fully charged state are to be used for the tests. The test program and number of samples to be used in each test is shown in Table 9.1.		P
9.2	All Power Banks shall be fully charged in accordance with the manufacturer's specifications prior to testing except for the samples to be subjected to the Abnormal Charging and Abusive Overcharge Tests, which shall be discharged to the manufacturer specified end-of-discharge voltage using the manufacturer specified current prior to testing.		N/A

UL 2056:2024			
Clause	Requirement + Test	Result - Remark	Verdict
10	Important test considerations		P
10.1	As some Power Banks explode in the tests, it is important that personnel be protected from the flying fragments, explosive force, sudden release of heat, chemical burns, and noise results from such explosions. The test area is to be well ventilated to protect personnel from possible harmful fumes or gases.		P
10.2	The temperatures on the surface of the cell casings shall be monitored during the tests described in Sections 12, 13, 14, 15, 16 and 18. All personnel involved in the testing of Power Banks are to be instructed never to approach a sample until the surface temperature returns to ambient temperature.		P
11	Temperature measurements		P
11.1	Temperatures are to be measured by thermocouples consisting of wires not larger than 0.21 mm ² (24 AWG) and not smaller than 0.05 mm ² (30 AWG) and a potentiometer-type instrument.	Suitable thermocouples used during the test.	P
11.2	The temperature measurements on the Power Bank are to be made with the measuring junction of the thermocouple held tightly against the outer enclosure of the Power Bank.	Fulfilled.	P
ELECTRICAL TESTS			
12	Short-Circuit of Output Port Test		P
12.1	Each fully charged test sample Power Bank, in turn, is to be short-circuited by connecting the positive and negative output port terminals of the Power Bank with a circuit load having a resistance load of 80 ±20 mΩ. The temperature of the internal cell casing is to be monitored during the test. The Power Bank is to discharge until a fire or explosion is obtained, or until it is completely discharged and/or the cell case temperature has returned to ±5 °C (±9 °F) of ambient temperature.		P
12.2	Tests are to be conducted at ambient temperatures of 20 ±5 °C (68 ±9 °F) and at 55 ±5 °C (131±9 °F). The Power Banks are to reach equilibrium at 20 ±5 °C (68 ±9 °F) or 55 ±5 °C (131 ±9 °F), as applicable, before the terminals output are connected.		N/A
12.3	Power Bank constructions are to be subjected to a single fault across any protective device in the load circuit of the Power Bank under test. When protective devices actuate during the test, the test shall be repeated with the Power Bank connected to the maximum load that does not cause the protective devices to		P

UL 2056:2024			
Clause	Requirement + Test	Result - Remark	Verdict
	open. See 5.26.		
Exception	A positive temperature coefficient device which complies with the tests specified in UL 1434, CSA C22.2 E60730-1 or UL 60730-1, or other protective devices determined to be reliable, may remain in the circuit without being faulted. See 5.26. Other standards that may apply are UL 248-14 / CSA C22.2 No. 248.14 and UL 60691 or CSA C22.2 No. 60691.		N/A
12.4	One of the five test sample Power Banks, tested at ambient temperature of $20 \pm 5 \text{ }^\circ\text{C}$ ($68 \pm 9 \text{ }^\circ\text{F}$) shall be evaluated with the following additional conditions in place. The output terminals are to be subjected to a resistive circuit load and shall have a maximum total resistance of 20 m Ω . The test is to be conducted on a tissue paper covered soft wood surface and the sample Power Bank and bare conductor are to be covered with a single layer of cheesecloth.		N/A
12.5	For Power Banks which enable their output(s) while the input power is applied, one of the test sample Power Banks apply the process as in 12.4 with the following additional conditions in place. The input terminals are to be subjected to the maximum charging rate and the output terminals are to be subjected to a resistive circuit load shall have a maximum total resistance of 20 m Ω at the same time. The test is to be conducted on a tissue paper covered soft wood surface and the sample Power Bank and bare conductor are to be covered with a single layer of cheesecloth.		N/A
12.6	For lithium chemistries, one of the test sample Power Banks, tested at ambient temperature of $20 \pm 5 \text{ }^\circ\text{C}$ ($68 \pm 9 \text{ }^\circ\text{F}$) shall be evaluated with the following additional conditions in place. The built-in battery is to be discharged at an initial current of 1.2 times of the maximum continuous discharge current of the built-in battery. No need to apply the single fault condition on the built-in battery's BMS. The temperature of the cell casing and the discharge current of the cell shall be monitored. The discharge is to continue until the cell or battery explodes, vents, or BMS operates, and the temperature of the internal cell casing reaches steady state conditions or returns to ambient. The test is to be conducted at the output point of the protecting circuit that accompanies the built-in battery. This means output converter circuitry of the Power Bank is to be bypassed to result in the evaluation of the protective circuitry for the battery.		P
12.7	For all samples tested, the samples shall not vent, explode, or catch fire and the tests shall not result in chemical leaks caused by cracking, rupturing or bursting of the cell casing. The temperature of the cell casings shall not exceed $75 \pm 1 \text{ }^\circ\text{C}$ ($167 \pm 2 \text{ }^\circ\text{F}$) for lithium chemistries. For Power Bank samples tested in accordance with 12.4, there shall be no charring or burning of the		P

UL 2056:2024			
Clause	Requirement + Test	Result - Remark	Verdict
	cheesecloth or tissue paper. Charring is defined as a blackening of the cheesecloth caused by combustion. Discoloration of the cheesecloth caused by smoke is acceptable. For the sample tested by 12.6, the cell's discharge current shall be no greater than its maximum continuous discharge current of the operation region.		
13	Abnormal Charging of the Battery Test		P
13.1	The Power Banks are to be tested in an ambient temperature of 20 ± 5 °C (68 ± 9 °F). A thermocouple is to be attached to the cells of each test sample Power Bank. Each Power Bank shall be discharged at a constant current of 0.2C/1 h, to a manufacturer specified end-of-discharge voltage of the built-in battery.		P
13.2	For lithium chemistries, one of the above five test samples in 13.1 shall be evaluated with the following additional conditions. The input voltage converter circuitry of the Power Bank is to be bypassed to result in evaluation of the lower limit discharge voltage protective circuitry for the built-in battery. The built-in battery is to be discharged at a constant current of 0.2C/1 h, to 10 % deeper than the manufacturer specified end-of-discharge voltage. No need to apply the single fault condition on the battery BMS. The temperature of the cell casing and the voltage of the cell shall be monitored. The discharge is to continue until the cell or battery explodes, vents, or BMS operates, and the temperature of the internal cell casing reaches steady state conditions or returns to ambient.		P
13.3	Each test sample Power Bank is to be subjected to the following abnormal charging conditions, in sequential order. a) The test is to be conducted at the input point of the protecting circuit that accompanies the built-in battery. This means input voltage converter circuitry of the Power Bank is to be bypassed to result in evaluation of the protective circuitry for the battery. b) The built-in battery is to be initially charged at the input point (a) using a constant current charging mode with an abnormal charging current limit of three times the built-in battery's maximum current specified by the manufacturer until the maximum specified abnormal charging voltage is reached. At that point, the built-in battery is to be charged with a constant maximum specified abnormal charging voltage of the built-in battery and an abnormal charging current limit of three times the battery maximum current. Charging duration is the time required to reach the manufacturer's specified end-of-charge conditions (voltage and current) plus seven additional hours. The temperature on the cell casing shall be monitored. A re-settable protective device such as a PTC that actuates during the test shall be allowed to reset and the test shall be resumed, cycling as often as necessary, but no less than 10 times, to complete the test. Automatic reset devices are allowed to		P

UL 2056:2024			
Clause	Requirement + Test	Result - Remark	Verdict
	<p>cycle during the test. When an overcurrent protective device operates during the test, the test is repeated with the same charging time, but with the battery connected to the maximum source that does not cause the protective devices to operate.</p> <p>NOTE: The current of three times the maximum current I_c calculation is based on the maximum current of built-in battery, not the maximum current of Power Bank.</p> <p>c) The charge condition in accordance with (b) shall be conducted with each single component fault that is likely to occur in the battery protection circuit and which would result in overcharging of the built-in battery.</p>		
Exception	A protective device determined to be reliable may remain in the circuit without being faulted. See 8.1 and 5.26.		N/A
13.4	For lithium chemistries, one of the test samples in 13.3 shall be evaluated with the following additional conditions in place. The built-in battery is to be initially charged at the input point in 13.3(a) using a constant current charging mode with an abnormal charging current of 20 % greater than the built-in battery's maximum current, specified by the manufacturer until the built-in battery's maximum specified charging voltage is reached. No need to apply the single fault condition on the battery BMS. The temperature of the cell casing and the charging current for the built-in battery shall be monitored. The test is to continue until the cell or battery explodes, vents, or BMS operates, and the temperature of the internal cell casing reaches steady state conditions or returns to ambient.		N/A
13.5	During the test, the temperature of the cell casings shall not exceed $90 \pm 1 \text{ }^\circ\text{C}$ ($194 \pm 2 \text{ }^\circ\text{F}$) for lithium chemistries.	See the test table for details	P
13.6	The samples shall not vent, explode, or catch fire. For Power Bank samples, tests shall not result in chemical leaks caused by cracking, rupturing or bursting of the cell casing. For the sample tested in accordance with 13.2, the voltage of the cell shall not be lower than its end-of-discharge voltage of the operation region. For the sample tested in accordance with 13.4, the charging current of the cell shall not exceed its maximum charging current of the operation region.	The sample did not leak, explode, or catch fire.	P
14	Abusive Overcharge of the Battery Test		P
14.1	The Power Banks are to be tested in an ambient temperature of $20 \pm 5 \text{ }^\circ\text{C}$ ($68 \pm 9 \text{ }^\circ\text{F}$).		P
14.2	The tests are to be conducted at the input point of the protecting circuit that accompanies the built-in battery. This means input		P

UL 2056:2024			
Clause	Requirement + Test	Result - Remark	Verdict
	voltage converter circuitry of the Power Bank is to be bypassed to evaluate the protection circuit for the built-in battery.		
14.3	The built-in batteries are to be subjected to a constant charging current at the input point of 14.2 at 10 times the C5 amp rate, using a supply voltage sufficient to maintain the 10 times C5 amp rate throughout the duration of the test. During the test, the temperature is to be measured on the internal cell casing of each sample. The test is to continue until the cell or battery explodes, vents, or a single operation protective device operates, and the temperature of the internal cell casing reaches steady state conditions or returns to ambient. If a PTC or other re-settable protection device operates during the test, it is to be reset a minimum of 10 times during the test. An automatic reset device is allowed to cycle during the test.		P
14.4	The charge condition in accordance with 14.2 shall be conducted with each single component fault that is likely to occur in the battery protection circuit and which would result in overcharging of the built-in battery.		P
Exception	Protective devices determined to be reliable, may remain in the circuit without being faulted.		P
14.5	For lithium chemistries, one of the above test samples in 14.3 shall be evaluated with the following additional conditions in place. The built-in battery is to be subjected to a constant charging maximum current I_c , specified by the manufacturer at the input point of 14.2 with a supply voltage 1.1 times the upper limit charging voltage for single cell/cell block batteries or 1.1 times the upper limit charging voltage per cell for series connected multi-cell batteries. No need to apply the single fault condition on BMS. The temperature on the cell casing and the charging voltage for the cell/cell block shall be monitored. The test is to continue until the cell or battery explodes, vents, or BMS operates, and the temperature of the internal cell casing reaches steady state conditions or returns to ambient.		P
14.6	At least one of the five samples shall be subjected to the test outlined in 14.3 and 14.4 with a constant current charge 5 times the C5 amp rate (e.g. at the C rate) with a supply voltage sufficient to maintain that rate throughout the duration of the test.		P
14.7	During the test, the temperature of the cell casings shall not exceed 90 ± 1 °C (194 ± 2 °F) for lithium chemistries.		P
14.8	The samples shall not explode or catch fire. For the sample tested by 14.5, the charging voltage of the cell shall not exceed its upper limit charging voltage of the operation region.		P

UL 2056:2024			
Clause	Requirement + Test	Result - Remark	Verdict
15	Forced-Discharge of the Cells Test		P
15.1	This test is intended for Power Banks with cells in multicell series applications cells that are to be used in multicell applications. The Power Banks are to be tested in an ambient temperature of 20 ±5 °C (68±9 °F).		P
15.2	For multi-cell series configurations without parallel strings a fully discharged cell is to be force-discharged by connecting it in series with fully charged cells of the same kind. The number of fully charged cells to be connected in series with the discharged cell is to equal the total number of cells in the pack less one.		N/A
15.3	For multi-cell series configurations with parallel strings, a fully discharged parallel string is to be force-discharged by connecting it in series with fully charged cells of the same kind. The number of fully charged cells to be connected in series with the discharged parallel string is to equal the total number of cells in the pack less the number of cells in the discharged parallel string. See Figure 15.1.		P
15.4	Each of the five Power Banks shall be prepared as described in 15.2 or 15.3, as applicable.		P
15.5	Once the fully discharged cells (or string of cells) are connected in series with the specified number of fully charged cells, the resultant battery is to be short circuited.		P
15.6	The positive and negative terminals of the sample are to be connected with a copper wire with a resistance load of 80 ±20 mΩ. The Power Bank is to discharge until a fire or explosion is obtained, or until it has reached a completely discharged state and the cell case temperature has returned to ±10 °C (±18 °F) of ambient temperature.		P
15.7	During the tests, Power Banks supplied with protective devices shall be subjected to a single component fault using any single fault condition which is likely to occur in the discharge circuit and which would result in excessive discharge of the battery.		P
Exception	A positive temperature coefficient device which complies with the applicable tests specified in UL 1434 and UL 60730-1 or CSA C22.2 E60730-1, or other protective devices determined to be reliable, may remain in the circuit without being faulted. Other standards that may apply are UL 248-14 / CSA C22.2 No. 248.14 and UL 60691 or CSA C22.2 No. 60691.		N/A

UL 2056:2024			
Clause	Requirement + Test	Result - Remark	Verdict
15.8	The samples shall not explode or catch fire.		P
16	Temperature Test and BMS Verification		P
16.1	A Power Bank shall be subjected to a normal temperature test under both input (charging) and output (discharging) conditions. As a result of this testing, temperatures on temperature sensitive components shall not exceed the limits outlined in Table 16.1 and Table 16.2.		P
16.2	For the output loading temperature test, a fully charged Power Bank shall be subjected to a constant resistive loading across the output ports of the Power Bank, at the maximum rated current of the output ports. Temperatures and cell voltages are monitored until thermal stabilization or until the built-in battery is at its rated end-of-discharge voltage, whichever comes first.		P
16.3	For the input loading temperature test, a fully discharged Power Bank shall be subjected to charging at maximum current as specified by the manufacturer. Temperatures and cell voltages are monitored until thermal stabilization or until the built-in battery is at its fully charged state, whichever comes first.		P
16.4	Temperatures are considered to be stabilized when three successive readings taken at intervals of 10 % of the previously elapsed duration of the test, but not less than 15 min, indicate no further increase.		P
16.5	Protective devices within the pack shall not operate during the test.		P
16.6	Temperatures are monitored on surfaces of components using thermocouples. Thermocouples are to consist of 0.05 mm ² (30 AWG) wires. Larger size wires may be used, but they shall not exceed 0.21 mm ² (24 AWG) and shall not be large enough to result in a heat sink condition on the part under test.		N/A
16.7	<p>During the normal temperature test, temperature measurement T shall not exceed: $(T_{max} + T_{amb} - T_{ma})$</p> <p>where:</p> <p>T is the temperature of the given part measured under the prescribed test,</p> <p>T_{max} is the maximum temperature specified for compliance with the test,</p>		P

UL 2056:2024			
Clause	Requirement + Test	Result - Remark	Verdict
	<p>T_{amb} is the ambient temperature during the test,</p> <p>T_{ma} is the maximum ambient temperature permitted by the manufacturer's specification, or 25 °C (77 °F), whichever is greater.</p> <p>During the test T_{amb} should not exceed T_{ma} unless agreed by all parties involved.</p>		
16.8	During the normal temperature test, cell voltages shall not be below the end-of-discharge voltage of the operation region in the output loading temperature test, and the cell voltages shall not exceed the upper limit charging voltage of the operation region in the input loading temperature test.		P
17	Power Input Test		P
17.1	The current input to a Power Bank shall not exceed 110 % of the marked input current rating of the Power Bank, when the Power Bank is operated under the conditions of maximum normal load.		P
17.2	Maximum normal load shall consist of the maximum power draw while the Power Bank is operating in all possible modes including the battery at different states of charge. This may include charging the built-in battery, output ports unloaded or loaded at the rated maximum normal load and the operation of auxiliary functions such as flashlight, speaker, etc. Any load that can be operated at the same time shall be considered in order to obtain the maximum normal load.		P
18	Overload of Output Ports Test		P
18.1	Each power output pin of output port shall be overloaded in accordance with 18.2 – 18.5.		P
18.2	In accordance with manufacturer's specifications, fully charge the built-in battery of Power Bank.		P
18.3	The Power Bank is covered with one layer of cheesecloth and placed on a softwood board covered with one layer of tissue paper.		P
18.4	Each power output pin of output port shall then be loaded to draw the maximum power, for 1 h or the maximum duration of operation permitted by the battery pack, whichever is less. For Power Banks which enable their output(s) while the input power is applied, the input terminals are to be subjected to the maximum charging rate at the same time during this test.		P

UL 2056:2024			
Clause	Requirement + Test	Result - Remark	Verdict
18.5	During the test, the samples shall not vent, explode, or catch fire. After this test, the cheesecloth and tissue paper shall remain intact (e.g. no discoloration or minor charring). The cell casing temperature shall not exceed the manufacturer's recommended maximum temperature.	No leakage or explosion occurred with the sample. Keep gauze and tissues intact	P
19	Flammability of Photovoltaic Cells Test		N/A
19.1	This test shall be conducted if the Power Bank is provided with integral photovoltaic cells as a power source.		N/A
19.2	In accordance with manufacturer's specifications, fully charge the built-in battery of the Power Bank.		N/A
19.3	The Power Bank is covered with one layer of cheesecloth and placed on a softwood board covered with one layer of tissue paper.		N/A
19.4	The Power Bank is subjected to single component fault that is likely to occur and which would result in flammability issue of the photovoltaic cells, such as back-feed of battery power, and is kept in this state for 1 h.		N/A
19.5	During this test, the battery shall not vent, explode, or catch fire. After this test, the cheesecloth and tissue paper shall remain intact (e.g. no discoloration or minor charring).		N/A
20	Capacity Verification Test		P
20.1	The marked electrical capacity of Power Bank, measured at the power output pin of output port, shall comply with IEC 61960-3, Clause 7.3.1, Discharge Performance at 20 °C (Rated Capacity) for lithium cell Power Bank or IEC 61951-2, Clause 7.3.2.3, Discharge performance for batteries at rated capacity (20 °C) for nickel cell Power Bank, and the modified test method in 20.2.		P
20.2	The Power Bank is discharged at a constant current equal to rated current of the output port, until its voltage is equal to the end-of-discharge voltage of the output port, specified by the manufacturer.		P
ENCLOSURE TESTS			
21	General		N/A

UL 2056:2024			
Clause	Requirement + Test	Result - Remark	Verdict
21.1	The Power Banks are to be tested in an ambient temperature of 20 ±5 °C (68 ±9 °F).		N/A
21.2	Power Banks with outer plastic enclosures shall be subjected to the tests described in Sections 22, 23, 24, and 25. Power Banks with outer enclosures made from materials other than plastic, shall be subjected to the tests described in Sections 22, 23, and 25.		N/A
22	Steady Uniform Force Test		P
22.1	The Power Banks are to be tested in an ambient temperature of 20 ±5 °C (68 ±9 °F).		P
22.2	The built-in battery of the Power Bank shall be fully charged in accordance with the manufacturer's specifications.		P
	External enclosures of the Power Bank are to be subjected to a steady force at a rate of 10 ±2.5 N/s (2.25 ±0.56 lbf/s) up to 250 ±10 N (56 ±2 lbf) and held for a period of 30 s, applied in turn to the top, bottom and sides of the Power Bank enclosure by means of a suitable test tool providing contact over a circular plane surface 30 mm (1.2 inch) in diameter. For cylindrical Power Banks, using external means to secure the product from rolling to allow the sides to be tested would be acceptable. Each side of a cylindrical Power Bank would be 90° rotation along the longitudinal axis.		P
	The samples shall not explode or catch fire. The outer enclosure shall not crack to the extent that the cells or any protective devices are exposed.		P
	The enclosure shall not separate as a result of the application of the steady force in accordance with 22.3.		P
	The sample shall be examined 6 h after testing and shall not vent, flame, explode, or leak as described in 7.2.		P
23	Flexing Force Test		P
23.1	Two Power Banks are to be tested in an ambient temperature of 20 ±5 °C (68 ±9 °F).		P
23.2	Each sample is to be tested in accordance with 23.3 – 23.6. The second sample shall be tested rotated 180° about its longitudinal		P

UL 2056:2024			
Clause	Requirement + Test	Result - Remark	Verdict
	axis from the orientation of the first sample.		
Exception	Power Banks with all external dimensions greater than 40 mm (1.6 inch) do not apply.		N/A
23.3	The built-in battery of the Power Bank shall be fully charged in accordance with manufacturer's specifications.		P
23.4	The test shall be set up as shown in Figure 23.1 using a suitable test tool providing contact with the center rod through a flat plate with a circular plane surface 30 mm (1.2 inch) in diameter.		P
	The Power Bank shall be placed with its longitudinal axis perpendicular to the 3.175 mm (1/8-inch) metal rods placed at opposite ends of the Power Bank, with the center of each rod not more than 6.35 mm (1/4 inch) from the edge of the enclosure. A 12.7 mm (1/2-inch) metal rod shall be placed on top of the Power Bank at the center of the longitudinal axis. The length of the metal rods shall be at least longer than the short axis of the Power Bank enclosure.		P
	A linear force shall be applied to the center rod at a steady rate at 10 N/s \pm 2.5 N (2.25 \pm 0.56 lbf) up to 250 \pm 10 N (56 \pm 2 lbf) and held for a period of 5 s.		P
	The samples shall not explode or catch fire during the test. The outer enclosure is permitted to crack to the extent that the cells or any protective devices are not exposed. Openings in the enclosure created as a result of the application of the 250 N (56 lbf) flexing force shall meet the criteria of 6.1.7.		P
	The sample shall be examined 6 h after testing and shall not vent, flame, explode, or leak as described in 7.2.		P
24	Mold Stress Relief Test		P
24.1	Each of three samples is to be placed in a full-draft circulating-air oven maintained at a uniform temperature of 70 \pm 1 $^{\circ}$ C (158 \pm 2 $^{\circ}$ F). The samples are to remain in the oven for 7 h.		P
Exception	If the maximum temperature, T, recorded on the battery pack thermoplastic enclosure parts, obtained during the normal temperature test of Section 16 exceeds 60 $^{\circ}$ C (140 $^{\circ}$ F), then the oven temperature is to be maintained at a temperature equal to T + 10 $^{\circ}$ C (50 $^{\circ}$ F).		P

UL 2056:2024			
Clause	Requirement + Test	Result - Remark	Verdict
24.2	To prevent hazards from overheating energized cells, samples shall either be fully discharged prior to conditioning or provided with "dummy" cells, which are representative of the actual cells.		P
24.3	After careful removal from the oven and after returning to room temperature following the conditioning described in 24.1, the samples shall show no evidence of mechanical damage that would result in damage to cells or protective circuitry. In addition, the enclosures shall not crack, warp, or melt to the extent that the cells or any protective devices are exposed. Openings in the enclosure created as a result of the conditioning shall meet the criteria of 6.1.7.		P
25	Drop Impact Test		P
25.1	The Power Banks are to be tested in an ambient temperature of 20 ±5 °C (68 ±9 °F).		P
Exception	Power Banks employing plastic enclosures that are intended for use in cold environment temperatures less than 5 °C (41 °F), the sample shall be conditioned for 3 h at 0 °C (32 °F) (or the minimum temperature specified by the manufacturer) prior to conducting the drop test, which shall be conducted immediately after removing the samples from the cold conditioning.		P
25.2	The built-in battery of the Power Bank shall be fully charged in accordance with manufacturer's specifications.		P
25.3	Each of three samples is to be dropped from a height of 1 m (3.28 ft) so it strikes a concrete surface in the position that is most likely to produce the adverse results in 25.4. Each sample is to be dropped three times in unique orientations.		P
25.4	The samples shall not vent, explode, or catch fire.		P
25.5	The sample shall be examined 6 h after testing and shall not vent or leak as described in 7.2, and the integrity of the protective devices shall be maintained.		P
25.6	The outer enclosure and any covers relied on for compliance to this Standard shall not crack. Any covers relied on for compliance to this Standard shall not separate or become detached.		P
26	Label Permanence Test		N/A

UL 2056:2024			
Clause	Requirement + Test	Result - Remark	Verdict
26.1	The purpose of this test is to evaluate the permanence of an adhesive label that has not been subjected to a previous evaluation program. See 27.1.		N/A
26.2	An adhesive label secured to a surface representative of the end use application and is subjected to the following conditioning: a) The label sample is rubbed by hand for 15 s with a piece of cloth soaked with water; and b) The sample is again rubbed for 15 s with a piece of cloth soaked with petroleum spirit.		N/A
26.3	The petroleum spirit to be used for the test is an aliphatic solvent hexane having: a) A maximum aromatics content of 0.1 % by volume; b) A kauributenol value of 29; c) An initial boiling point of approximately 65 °C (149 °F); d) A dry point of approximately 69 °C (156.2 °F); and e) A mass per unit volume of approximately 0.7 kg/L.		N/A
	Exception: As an alternative, it is permitted to use a reagent grade hexane with a minimum of 85 % as nhexane.		N/A
26.4	After the conditioning outlined in 26.2, the sample is to be examined for signs of damage including curing and to determine if the marking is still legible. The sample is also examined to determine if it can be removed easily by hand from the surface.		N/A
26.5	As a result of the conditioning, the sample label shall remain legible, show no evidence of damage including curling and shall not be able to be easily removed by hand from the adhered surface.		N/A
MARKINGS			
27	General		N/A
27.1	The markings required for compliance with this Standard shall be legible and permanent such as etched, adhesive labels, etc. An adhesive-backed label shall comply with the requirements in UL 969 or CSA C22.2 No. 0.15, for the intended exposure conditions and surface adhered to.		N/A

UL 2056:2024			
Clause	Requirement + Test	Result - Remark	Verdict
Exception	Adhesive labels may be alternately evaluated to the Label Permanence Test in Section 26.		N/A
27.2	<p>A Power Bank shall be legibly and permanently marked with:</p> <p>a) The manufacturer's name, trade name, or trademark or other descriptive marking by which the organization responsible for the product may be identified;</p> <p>b) A distinctive ("catalog" or "model") number or the equivalent;</p> <p>c) Input rating in Vdc or Vac with frequency, and A. If there is more than one input port, the rating of each port shall be provided. Symbol IEC 60417-5032 can be used for ac and symbol IEC 60417-5031 can be used for dc;</p> <p>d) Output rating in Vdc and A. If there is more than one output port, the rating of each port and the combined rating (if it is not equal to the summation of all ports) shall be provided;</p> <p>e) Electrical capacity in Ah or mAh. If there is more than one output port/output rating, either the capacity of each port/rating shall be provided, or the minimum capacity of these ports/ratings shall be provided;</p> <p>f) Electrical capacity in Wh of the built-in battery;</p> <p>g) The date or other dating period of manufacture not exceeding any three consecutive months; and</p> <p>h) The chemistry type of the Power Bank.</p>		N/A
Exception No. 1	The manufacturer's identification may be in a traceable code if the product is identified by the brand or trademark owned by a private labeler.		N/A
Exception No. 2	<p>The date of manufacture may be abbreviated; or may be in a nationally accepted conventional code or in a code affirmed by the manufacturer, provided that the code:</p> <p>a) Does not repeat in less than 10 years; and</p> <p>b) Does not require reference to the production records of the manufacturer to determine when the product was manufactured.</p>		N/A
27.3	When a manufacturer produces the Power Bank at more than one factory, each Power Bank shall have a distinctive marking to identify it as the product of a particular factory.		N/A
27.4	The following or equivalent wording shall be permanently and legibly marked on the Power Bank:		N/A

UL 2056:2024			
Clause	Requirement + Test	Result - Remark	Verdict
	<p>“CAUTION: Risk of Fire and Burns. Do Not Open, Crush, Heat Above (manufacturer’s specified maximum temperature) or Incinerate. Follow Manufacturer’s Instructions.” This wording or equivalent shall also be included in the instructions supplied with the Power Bank.</p>		
27.5	<p>The markings shall be of contrasting colors or light versus dark of the enclosure, such that contrasting colors are those that sit opposite each other on the color wheel. Examples of contrasting color pairs are: Black and White, Red and Green, Blue and Orange, Yellow and Purple.</p>		
INSTRUCTIONS			
28	General		N/A
28.1	<p>Power Banks shall be provided with legible instructions pertaining to a risk of fire or injury to persons associated with the use of the product.</p>		N/A
28.2	<p>An illustration is allowed with a required instruction to clarify the intent but shall not replace the written instruction.</p>		N/A
	<p>The following instructions shall be provided with the Power Bank in the form of a manual, stuffer sheet or on packaging. The instructions may additionally be repeated via markings provided directly on the Power Bank:</p> <p>a) Instructions for operating and charging the Power Bank, including the operating temperature range and charging temperature range for the Power Bank; and</p> <p>b) Instructions for storing and disposing of the Power Bank, including the storage temperature range for the Power Bank.</p>		
29	Instructions Pertaining to Risk of Fire or Injury to Persons		P
29.1	<p>Instructions pertaining to a risk of fire or injury to persons shall warn the user of reasonably foreseeable risks and state the precautions to be taken to reduce such risks. Such instructions shall be preceded by the heading "INSTRUCTIONS PERTAINING TO RISK OF FIRE OR INJURY TO PERSONS" or the equivalent.</p>		P
29.2	<p>Unless otherwise indicated, the text of the instructions in 29.4 shall be in the words specified or words that are equivalent, clear, and understandable. Substitution of the signal word "DANGER" for "WARNING" is allowed when the risk associated with the product is such that a situation exists which, if not avoided, will result in death or serious injury.</p>		P



UL 2056:2024			
Clause	Requirement + Test	Result - Remark	Verdict
29.3	Numbering of the items in the list in 29.4 and including other instructions pertaining to a risk of fire or injury to persons that the manufacturer determines to be necessary and that do not conflict with the intent of the instructions are acceptable.		P
29.4	The instructions pertaining to a risk of fire or injury to persons shall include those items in the following list that are applicable to the product. The statement "IMPORTANT SAFETY INSTRUCTIONS" or the equivalent shall precede the list, and the statement "SAVE THESE INSTRUCTIONS" or the equivalent shall either precede or follow the list. The word "WARNING" shall be entirely in upper case letters or shall be emphasized to distinguish it from the rest of the text.		P
ANNEX A	(Normative for Canada and Informative for the US) – SAFETY MARKING TRANSLATIONS		P

12	TABLE: Short-Circuit Test					P
At 20±5°C						
Sample No.	B01	B02	B03	B04 (cl.12.4/12.5)	B05 (cl.12.6)	
Ambient temp. (°C)	22.4	22.8	22.6	22.7	22.5	
Max. cell casing temp. (°C)	32.8	33.9	31.7	36.0	23.8	
Single fault condition	MOSFET U3(Pin1-Pin2) S-C	MOSFET U3(Pin1-Pin2) S-C	MOSFET U3(Pin1-Pin2) S-C	MOSFET U3(Pin1-Pin2) S-C	/	
At 55±5°C						
Sample No.	B06	B07	B08	B09	B10	
Ambient temp. (°C)	55.8	55.7	55.6	55.5	55.7	
Max. cell casing temp. (°C)	62.5	64.6	63.7	63.8	61.6	
Single fault condition	MOSFET U3(Pin1-Pin2) S-C	MOSFET U3(Pin1-Pin2) S-C	MOSFET U3(Pin1-Pin2) S-C	MOSFET U3(Pin1-Pin2) S-C	/	
Supplementary information:						
Tmax was recorded on the centre of the cell casing;						
No vent, explosion or fire, or chemical leak, no chemical leaks caused by cracking, rupturing or bursting of the cell casing;						
The temperature of the Li-ion cell casings does not exceed 75 ±1 °C (167 ±2 °F);						
Cheesecloth and tissue paper not catch fire for the sample tested as cl.12.4 and 12.6 required.						
S-C=short-circuit.						

13	TABLE: Abnormal Charging of the Battery Test					P
3*Ic=15.0A			Uc=20V			
Sample No.	B11	B12	B13	B14 (cl. 13.2)	B15 (cl. 13.4)	
Ambient temp. (°C)	22.3	22.4	22.5	22.7	22.6	
Max. cell casing temp. (°C)	35.1	35.8	36.1	30.2	31.8	
Single fault condition	MOSFET U3(Pin1-Pin3) S-C	MOSFET U3(Pin1-Pin3) S-C	MOSFET U3(Pin1-Pin3) S-C	--	--	

Supplementary information:

Tmax was recorded on the centre of the cell casing;

For the sample tested in accordance with 13.2, the lowest voltage of the cell during the test is 3V

For the sample tested in accordance with 13.4, the Max. charging current of the cell during the test is 9.0A

No vent, explosion or fire, or chemical leak, no chemical leaks caused by cracking, rupturing or bursting of the cell casing.

During the test, the temperature of the cell casings shall not exceed 90 ± 1 °C for lithium chemistries.

S-C=short-circuit.

14	TABLE: Abusive Overcharge of the Battery Test					P
Sample No.	B16	B17	B18	B19	B20 cl. 14.5	
Charge current (A)	15.6	15.6	15.6	7.8	7.8	
Ambient temp. (°C)	22.8	22.6	22.7	22.6	22.5	
Max. cell casing temp. (°C)	40.5	42.7	44.8	45.3	31.6	
Single fault condition	MOSFET U3(Pin1-Pin2) S-C	MOSFET U3(Pin1-Pin2) S-C	MOSFET U3(Pin1-Pin2) S-C	MOSFET U3(Pin1-Pin2) S-C	--	

Supplementary information:

Tmax was recorded on the centre of the cell casing;

For the sample tested by 14.5, the Max. charging voltage of the cell is 4.2V.

No explosion or fire;

The temperature of the cell casings shall not exceed 90 ± 1 °C (194 ± 2 °F) for lithium chemistries.

S-C=short-circuit.

15	TABLE: Forced-Discharge of the Cells Test					P
Sample No.	B21	B22	B23	B24	B25	
Ambient temp. (°C)	22.8	22.7	22.6	22.6	22.8	
Max. cell casing temp. (°C)	34.1	34.8	35.1	34.2	34.8	
Single fault condition	MOSFET U3(Pin1-Pin2) S-C	MOSFET U3(Pin1-Pin2) S-C	MOSFET U3(Pin1-Pin2) S-C	MOSFET U3(Pin1-Pin2) S-C	MOSFET U3(Pin1-Pin2) S-C	

Supplementary information:

Tmax was recorded on the centre of the cell casing;

16	TABLE: Temperature Test and BMS Verification						P
Sample No.	B26		B27		Limited T		
Testing Process	Charging	Discharging	Charging	Discharging	Charging	Discharging	
PCB near U1	68.7	71.6	67.6	73.6	130+22.8-50=102.8	130+22.6-50=102.6	
PCB near Output	65.3	53.7	63.3	54.1	130+22.8-50=102.8	130+22.6-50=102.6	
PCB near U3	72.6	64.3	76.3	62.8	130+22.8-50=102.8	130+22.6-50=102.6	
PCB near cell	63.9	58.7	58.5	64.7	130+22.8-50=107.8	130+22.6-50=102.6	
The outer shell is located near the component on the exterior side.	42.7	40.9	45.2	41.7	90+22.8-50=62.8	90+22.6-50=62.6	
The housing is located near the inside of the assembly.	40.8	37.6	41.7	36.8	90+22.8-50=62.8	90+22.6-50=62.6	
Battery							
Cell surface	35.6	36.2	36.7	35.7	Ref.	Ref.	
Ambient	22.8	22.6	22.8	22.6	--	--	
Supplementary information: Measurement temperature T not exceed ($T_{max} + T_{amb} - T_{ma}$); Temperatures on temperature sensitive components shall not exceed the limits outlined in Table 16.1 and Table 16.2. For input loading, the battery charged with 3.53A and 4.18V; Max. cell voltage during input test is 4.2V not exceed the upper limit of the charging voltage specified by the cell manufacturer. For output loading, the battery discharged with 3.48A until 3.10V; Min. cell voltage during output test is 3.0V, not exceed the lower limit of the discharging voltage specified by the cell manufacturer.							

17	TABLE: Power Input Test						P
Sample No.	U (V)	Hz	I (A)	I rated (A)	Power (W)	Condition/status	
B28	5.12	--	3	3	15.36	Supplied by DC source, only internal fully discharged battery was charged.	
Supplementary information: The current input to a Power Bank not exceed 110 % of the marked input current rating of the Power Bank.							

18	TABLE: Overload of Output Ports Test	P
----	--------------------------------------	---

Sample No.	OCV before test (Vdc)	Test time	Loaded Current (A)	Maximum case temperature (°C)	Results
B29	5.11	1h	3	37.6	P

Supplementary information:

No vent, explode, or catch fire. After this test, the cheesecloth and tissue paper shall remain intact.

19	TABLE: Flammability of Photovoltaic Cells Test			N/A
Sample No.	OCV before test (Vdc)	Single fault condition	Vent, explode, or catch fire?	
--	--	--	Yes / No	

Supplementary information:

After this test, the cheesecloth and tissue paper remain intact.

S-C=short-circuit.

20	TABLE: Capacity Verification Test				P
Sample No.	Cycle No.	OCV before test (Vdc)	Discharged Current (A)	Measured Capacity (mAh)	Results
B30	1	5.12	3.0	159377	P
	2	5.12	3.0	159374	P
	3	5.12	3.0	159371	P
	4	5.11	3.0	159376	P
	5	5.12	3.0	159373	P

Supplementary information:

The capacity of Power Bank is not less than 100% of the marked capacity rating.

22	TABLE: Steady Uniform Force Test			P
Ambient temperature: 23.1°C				
Sample No.	B31	B32	B33	
Mass before test (g)	597.5	597.3	598.6	
Mass after test (g)	597.5	597.3	598.6	
Mass loss ratio (%)	0.000	0.000	0.000	

Supplementary information:

No explode or fire, no vent, flame or leak after 6h of testing.

23	TABLE: Flexing Force Test		P
Ambient temperature: 23.0°C			
Sample No.	B34	B35	
Mass before test (g)	598.1	597.6	
Mass after test (g)	598.1	597.6	
Mass loss ratio (%)	0.000	0.000	
Supplementary information:			
No explode or fire, no vent, flame or leak after 6h of testing.			

24	TABLE: Mold Stress Relief Test			P
Ambient temperature: 23.4°C				
Sample No.	B36	B37	B38	
Mass before test (g)	598.1	597.6	597.1	
Mass after test (g)	598.1	597.6	597.1	
Mass loss ratio (%)	0.000	0.000	0.000	
Supplementary information:				
No evidence of mechanical damage that would result in damage to cell or protective circuitry after test.				

25	TABLE: Drop Impact Test			P
Ambient temperature: 23.7°C				
Sample No.	B39	B40	B41	
Mass before test (g)	597.3	598.4	598.5	
Mass after test (g)	597.3	598.4	598.5	
Mass loss ratio (%)	0.000	0.000	0.000	
Supplementary information:				
No explode or fire, no vent, flame or leak after 6h of testing.				

Sample photo

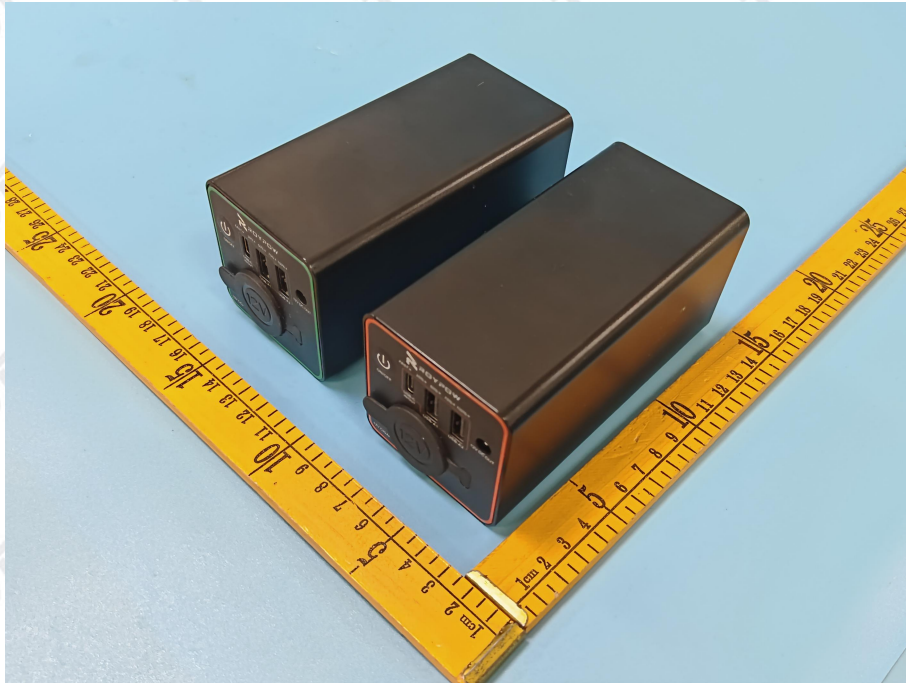

Photo 1
Overview of battery



Photo 2
Overview of battery



Photo 3

Overview of battery



Photo 4

Overview of battery

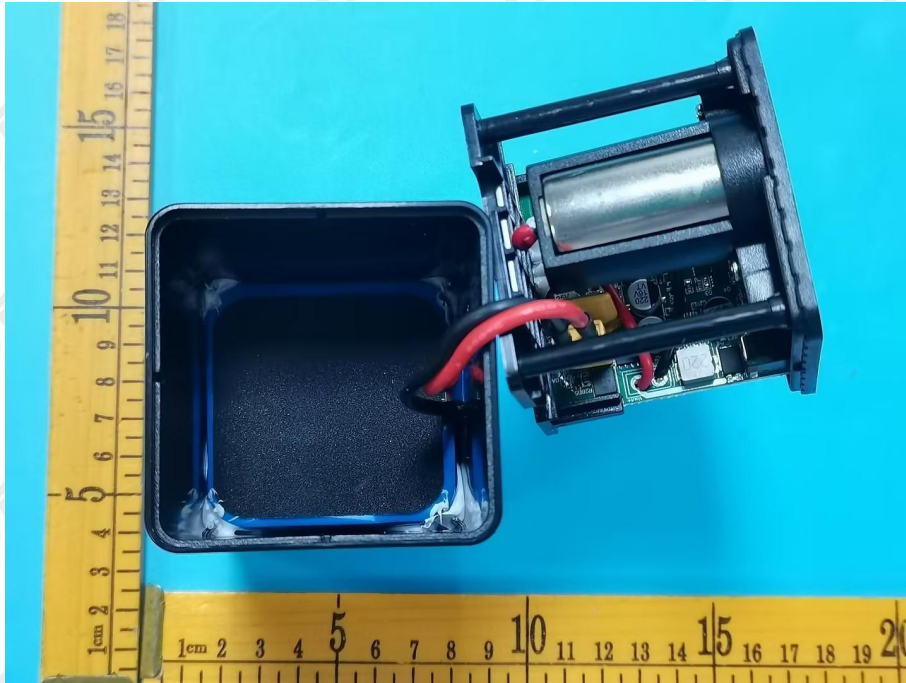

Photo 5
Internal view of battery



Photo 6
Internal view of battery



Photo 9
Battery

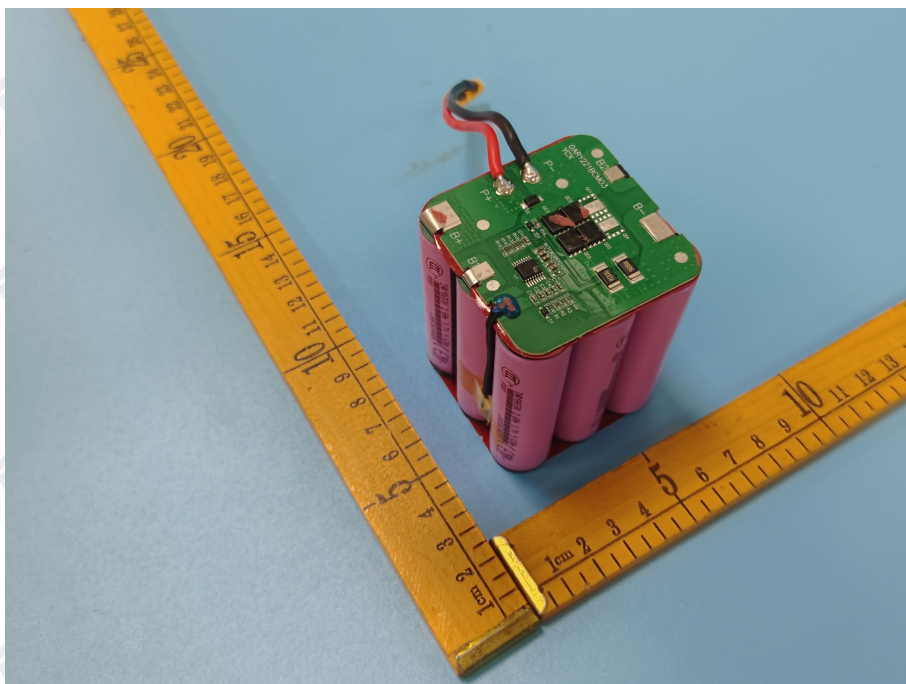

Photo 10
Internal view of battery

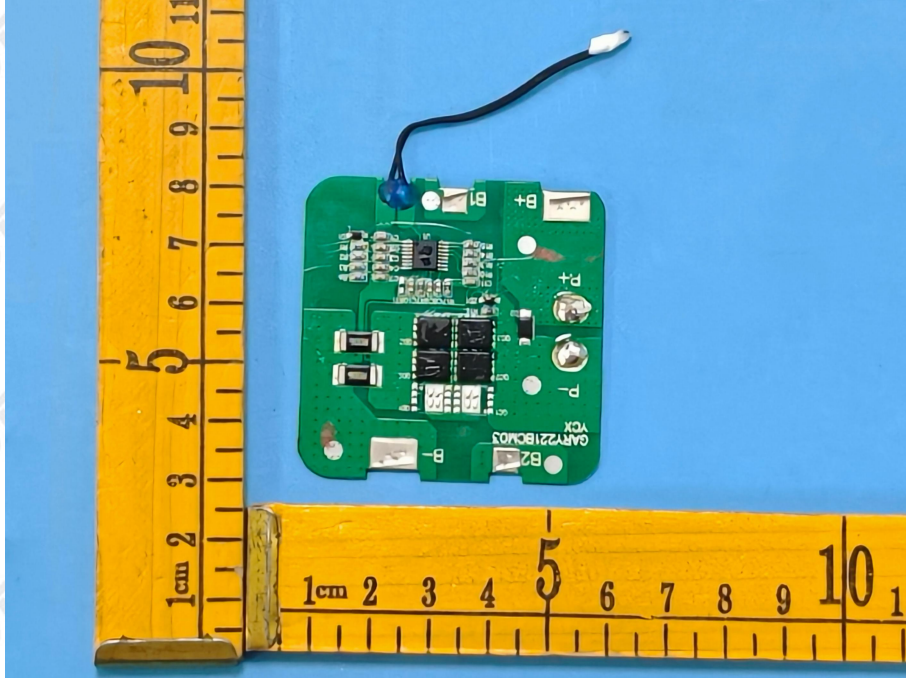

Photo 11

PCB board front view

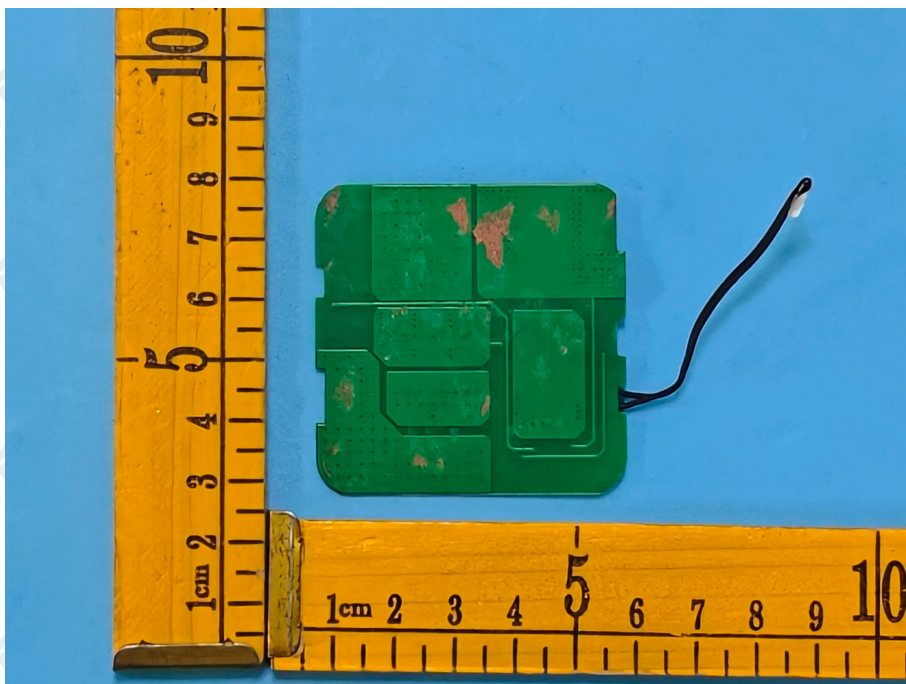

Photo 12

PCB backside view



Photo 13
Cell view

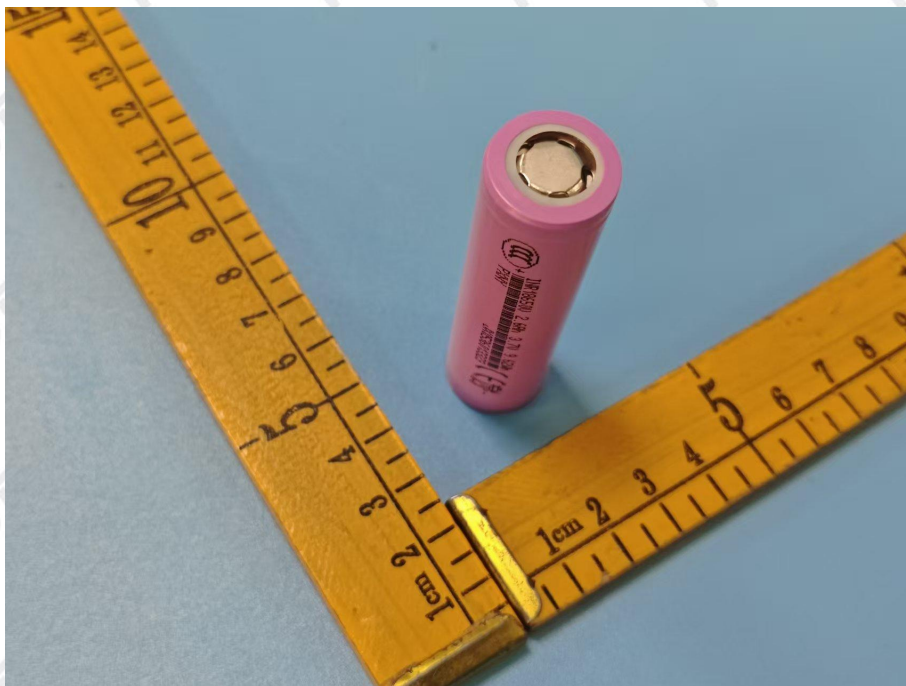

Photo 14
Cell view

---End of report---